The image features a central logo consisting of the words "UNLIMIT" and "INDIA" stacked vertically in a white, sans-serif font. The text is centered against a black background. Surrounding the text are several concentric, glowing rings in shades of blue and red, creating a tunnel-like or portal effect. The rings are slightly blurred, giving a sense of depth and motion.

UNLIMIT
INDIA

The image features a central graphic with the text "UNLIMIT INDIA" in a white, stylized, sans-serif font. The text is set against a background of a blue and white Earth from space, with a bright sun rising over the horizon. The scene is framed by several concentric, glowing circular light trails in shades of blue and magenta. The overall aesthetic is futuristic and high-tech.

UNLIMIT
INDIA

The image features two hands, one from the top and one from the right, reaching towards each other. The background is a deep blue with dynamic, diagonal streaks of red and white light, creating a sense of movement and energy. The hands are lit with a soft, ethereal glow, emphasizing their form and the space between them.

INSIGHT

Timeless emotions. Timeless choices.

In an ever-changing world, *love* the most powerful human emotion has remained eternal. It inspires our deepest choices and defines who we are.

It is a journey that begins with a spark, uncovering layers and growing ever richer with time.

BRAND IDEA

Unlimit Love. Unlimit Life.

At the heart of the choices consumers make is Love that unlimits their potential in every way.

Experience *Unlimit Love* through our products, crafted for an unmissable presence, unparalleled technology, and unrivalled performance.



BRAND IDENTITY

Life is the perfect embodiment of circularity—a seamless, endless flow of energy and growth. It reflects a lifestyle in perpetual evolution, constantly seeking boundless experiences.

Our identity intertwines the infinity symbol with the letter M, a graceful tribute to this *unlimit* journey of human life.



HEARTCORE
DESIGN

BE BRAND PERSONALITY

BE

Be Bold. Be Fierce. Be Limitless. Just BE.



BE 6E

Design story



XEV BRAND PERSONALITY

XEV

Xperience Suave Indulgence



XEV 90

Design story



A comparison of our two world-beating icons with
4 Luxury Brands with
price ranging between ₹ 50-70 Lakh*



*Ex-Showroom (UK) with VAT
GBP-INR Exchange Rate: 107

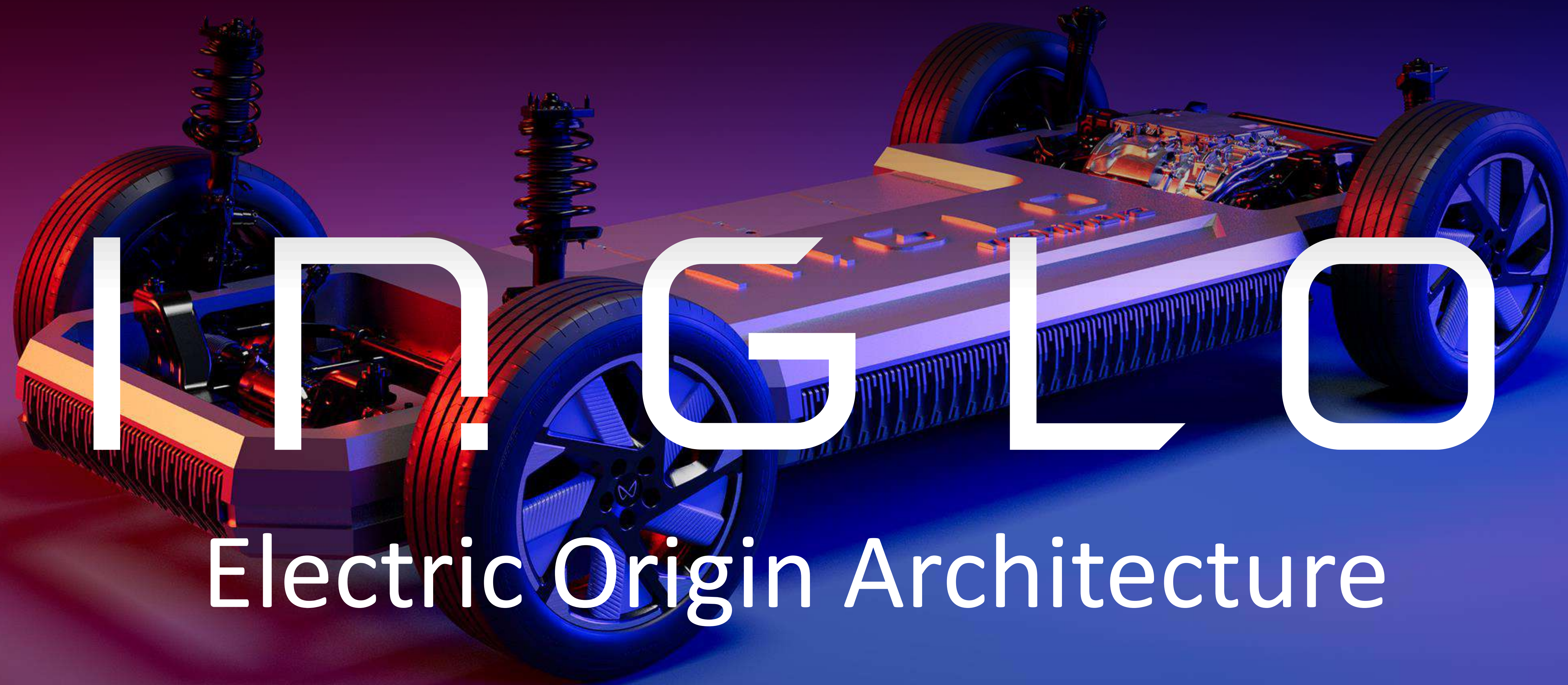

INGLO

Electric Origin Architecture

~1632



Galileo

1687



Isaac Newton

1824



Sadi Carnot

1876



Nicolaus Otto

1885

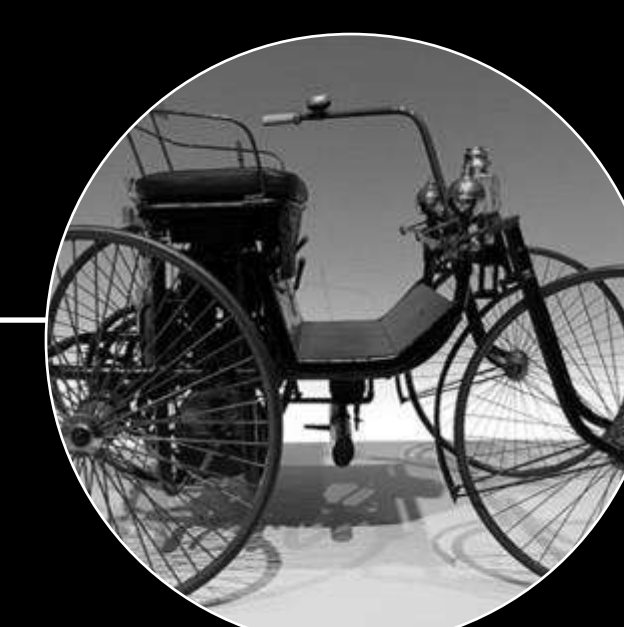

Birth of Automobile

Mechanical Origin

1752



Benjamin Franklin

1790



Alessandro Volta

1821

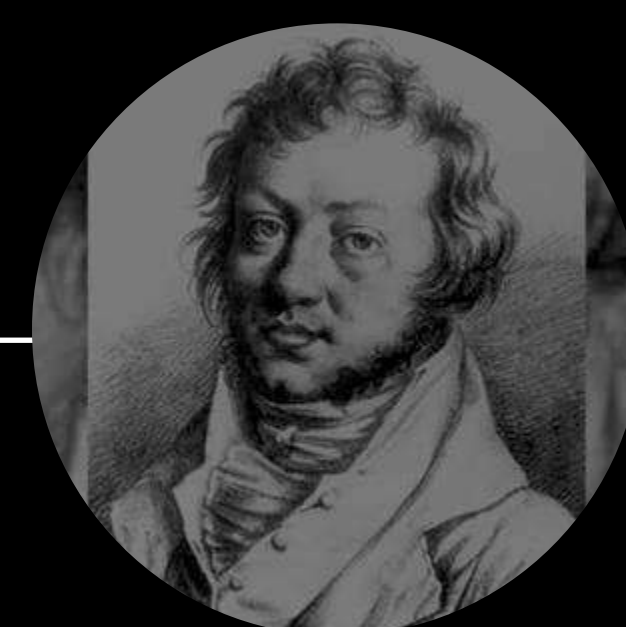

Marie Ampere

1831

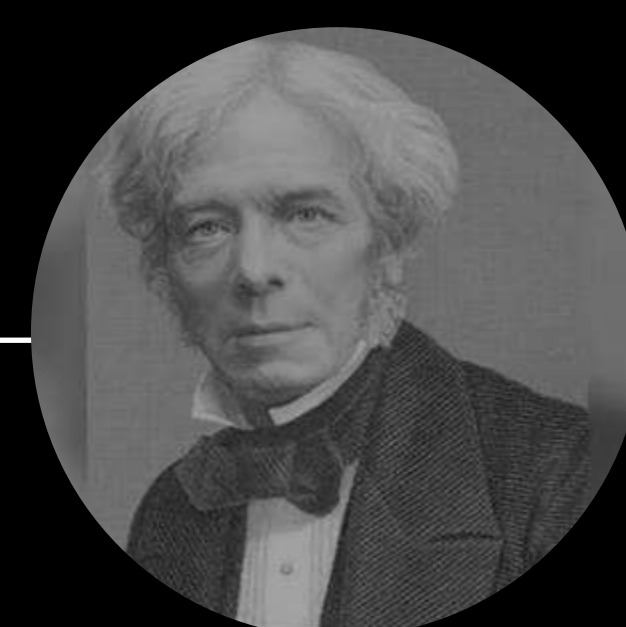

Michael Faraday

1885



James Maxwell

1890

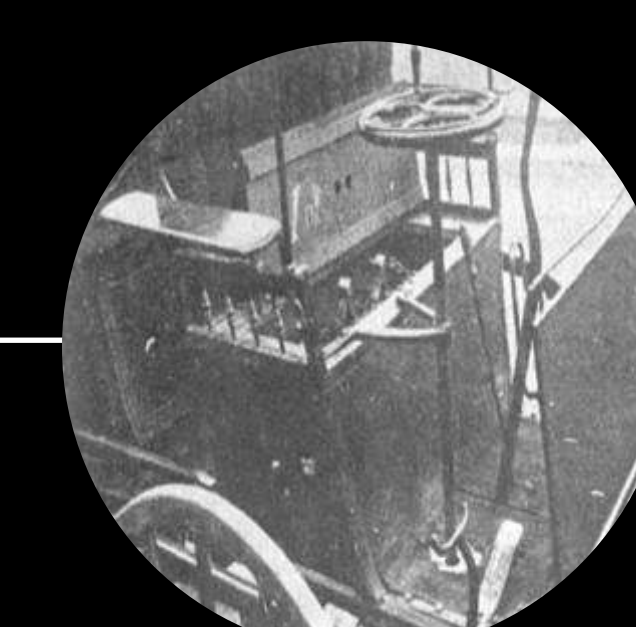

1st Electric
Automobile

Electric Origin

- **Energy**
- **Efficiency**
- **Safety**

INGLO is a benchmark in innovation

152 patents* & 45 design registrations*

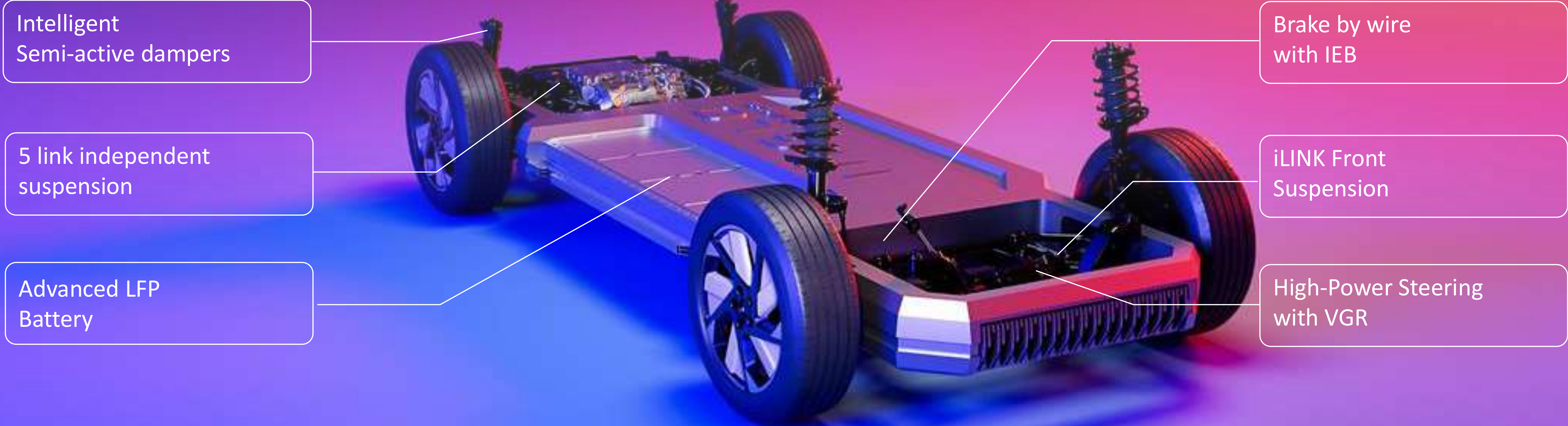

* Patents & Design registrations applied

BE 6e and XEV 9e – both on INGLO

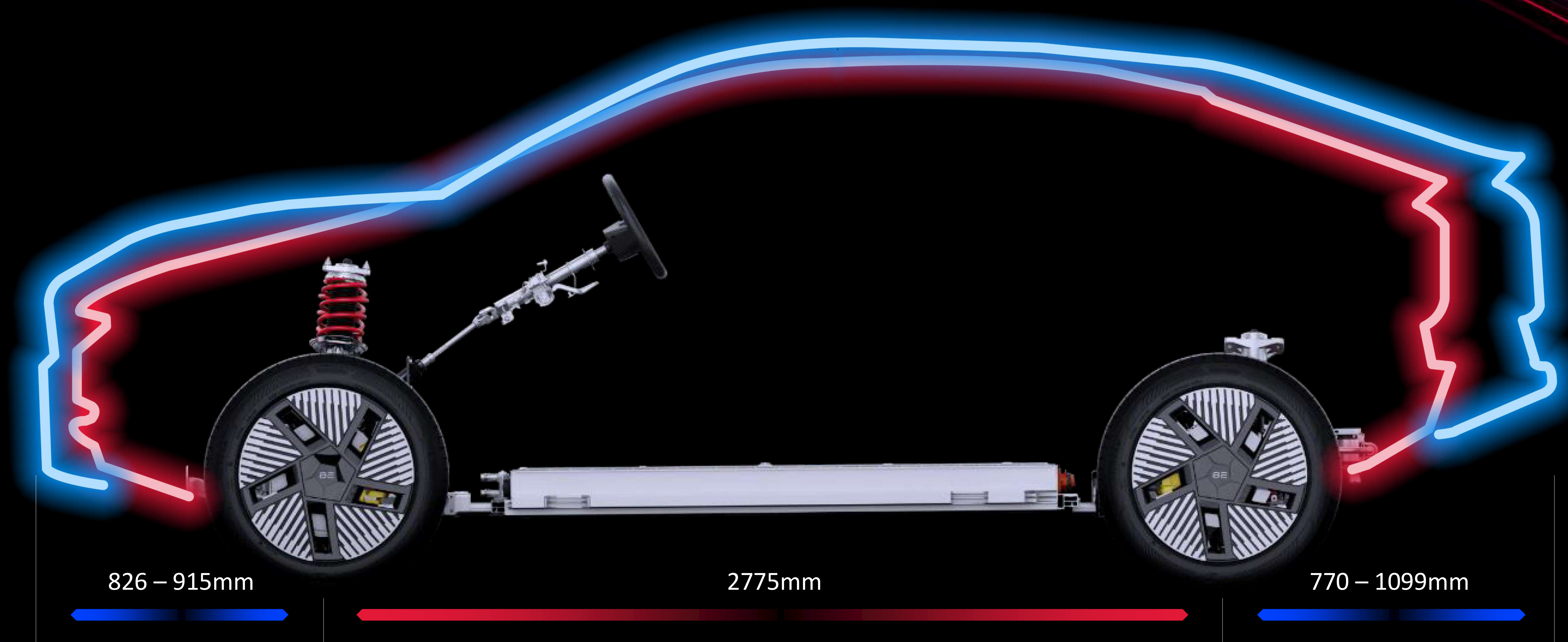

INGLO enables Mahindra's core SUV DNA

The best battery ground clearance and command seat position

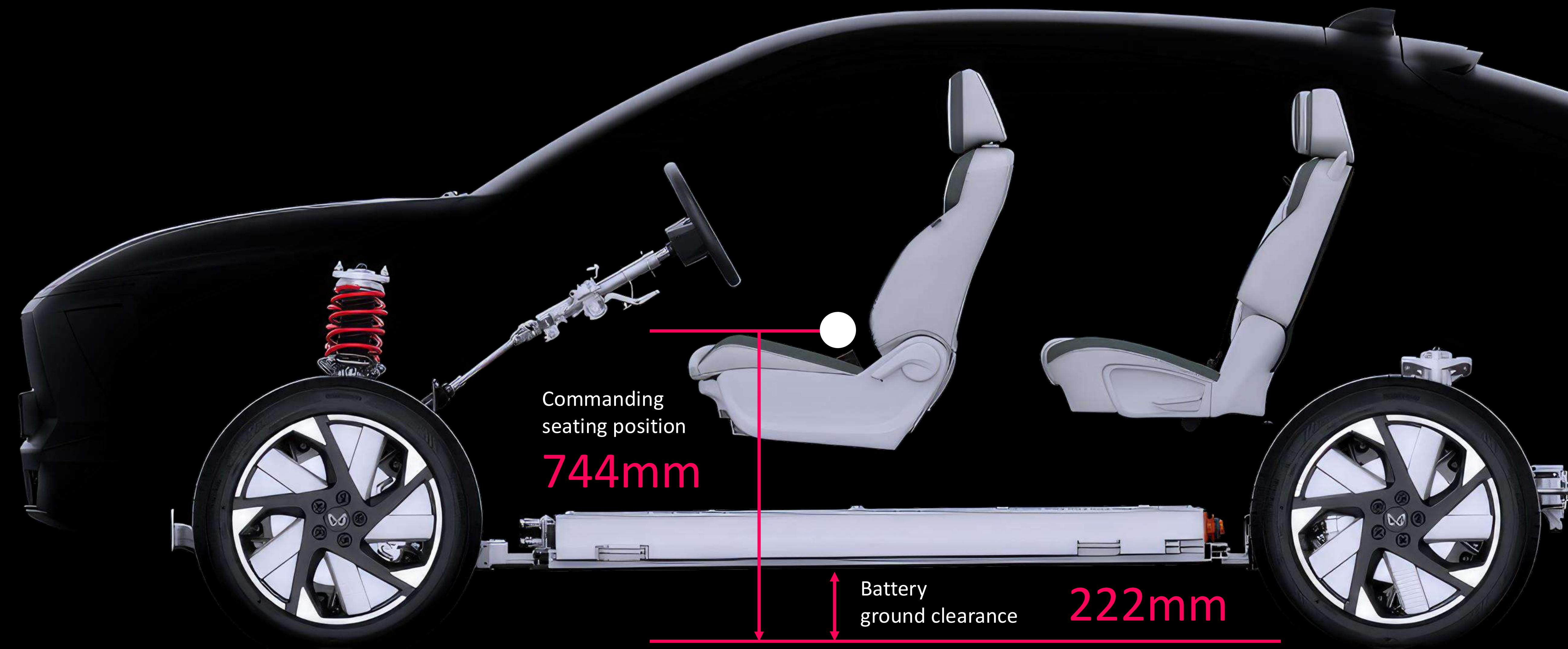

Dimension	XEV 9e	Luxury 1	Luxury 2	Luxury 3	Luxury 4	BE 6e
Overall ground clearance (mm)	207	172	179	176	192	207
Battery ground clearance (mm)	222	172	186	186	207	218
Driver H point (mm)	744	685	680	644	662	691
Vehicle length	4789	4765	4734	4591	4464	4371

Source : Inhouse measurements

1617 litres of Front Cabin Space That's the best

Dimension	XEV 9e	Luxury 1	Luxury 2	Luxury 3	Luxury 4	BE 6e
Front cabin space (lit)	1617	1539	1580	1573	1499	1522
Headroom (mm)	1006	1024	1028	1022	1008	1003
Legroom (mm)	1055	1051	1052	1070	1043	1064
Shoulder room (mm)	1522	1430	1461	1438	1426	1436

Source : Inhouse measurements



XEV 9e – The best Boot & Frunk Space

Dimension	XUV 9e	Luxury 1	Luxury 2	Luxury 3	Luxury 4	BE 6e
Boot volume* (litres)	663	563	400	412	314	455
Frunk volume (litres)	150	117	No frunk	No frunk	No frunk	45
Overall vehicle length (mm)	4765	4765	4734	4591	4464	4371

Source : Inhouse measurements

Boot

663 litres

Frunk

150 litres

* Boot volume measured up to backrest as per VDA – ISO V 211



INGLO enables the best vehicle dynamics



Ride comfort

Handling

Ease of use

Fun to drive

Overall vehicle dynamics : evaluation by Applus IDIADA, Spain



Setting a new standard in RIDE quality with The Intelligent semi-active suspension

15 ms

Real-time control
of damping force

Ride modes

Power of choice

Ride comfort – Road inputs isolation

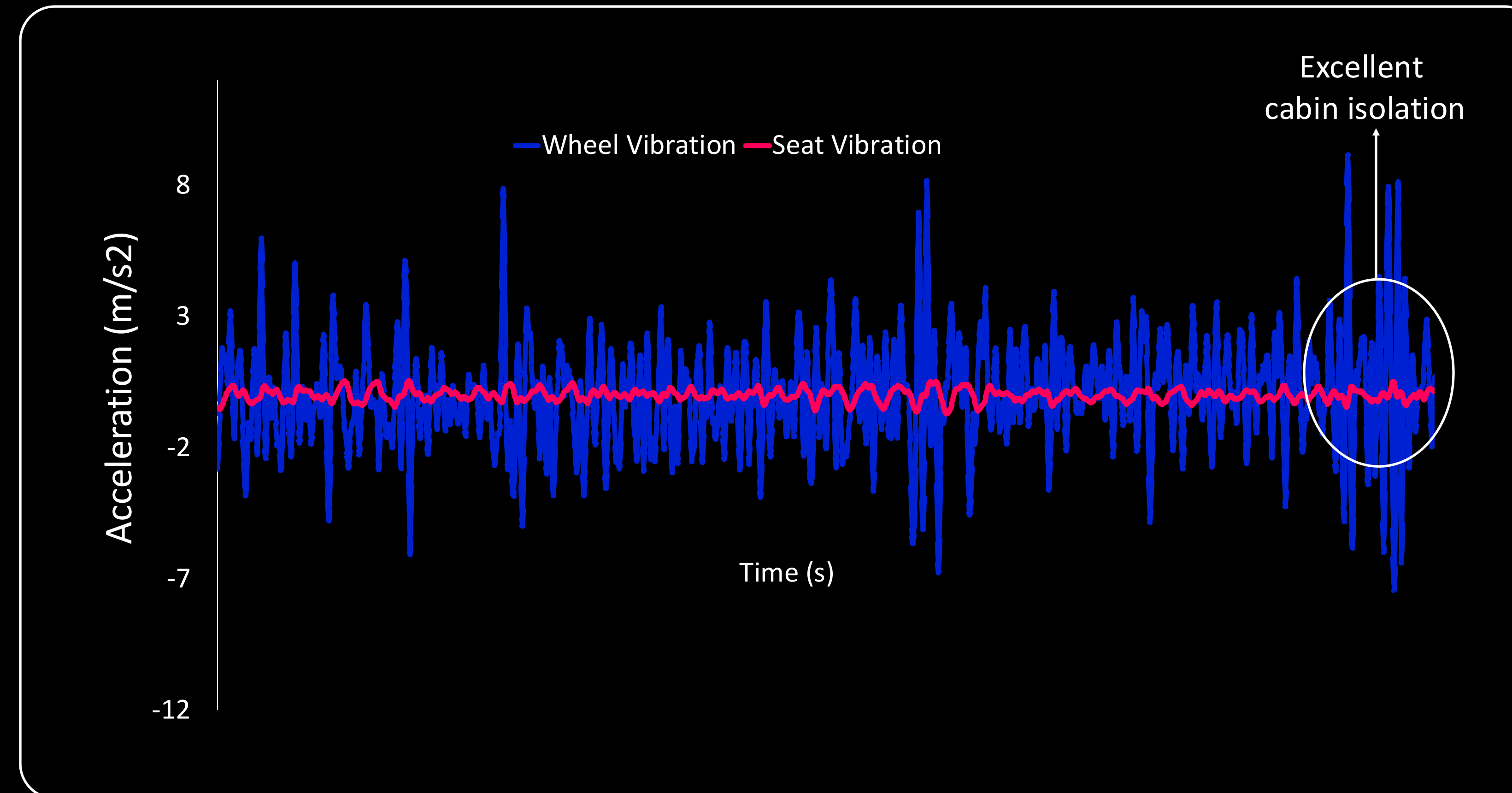

Ride comfort* : evaluation by Applus IDIADA, Spain



* BE and XEV tested with R19 test results

One of the quietest in-car experiences

Articulation Index (Sound Quality) Driver-ear noise

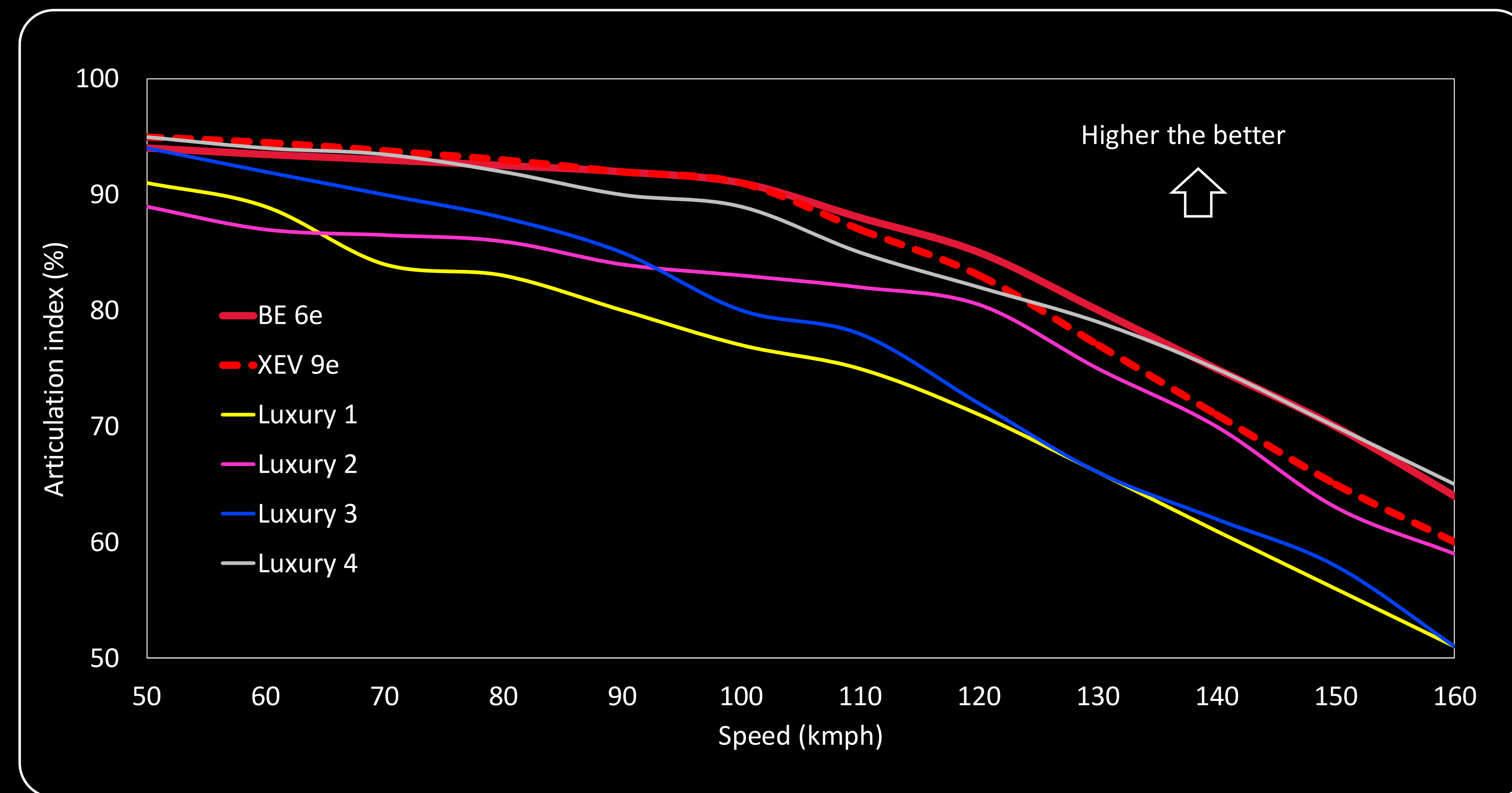

Source : Inhouse measurements

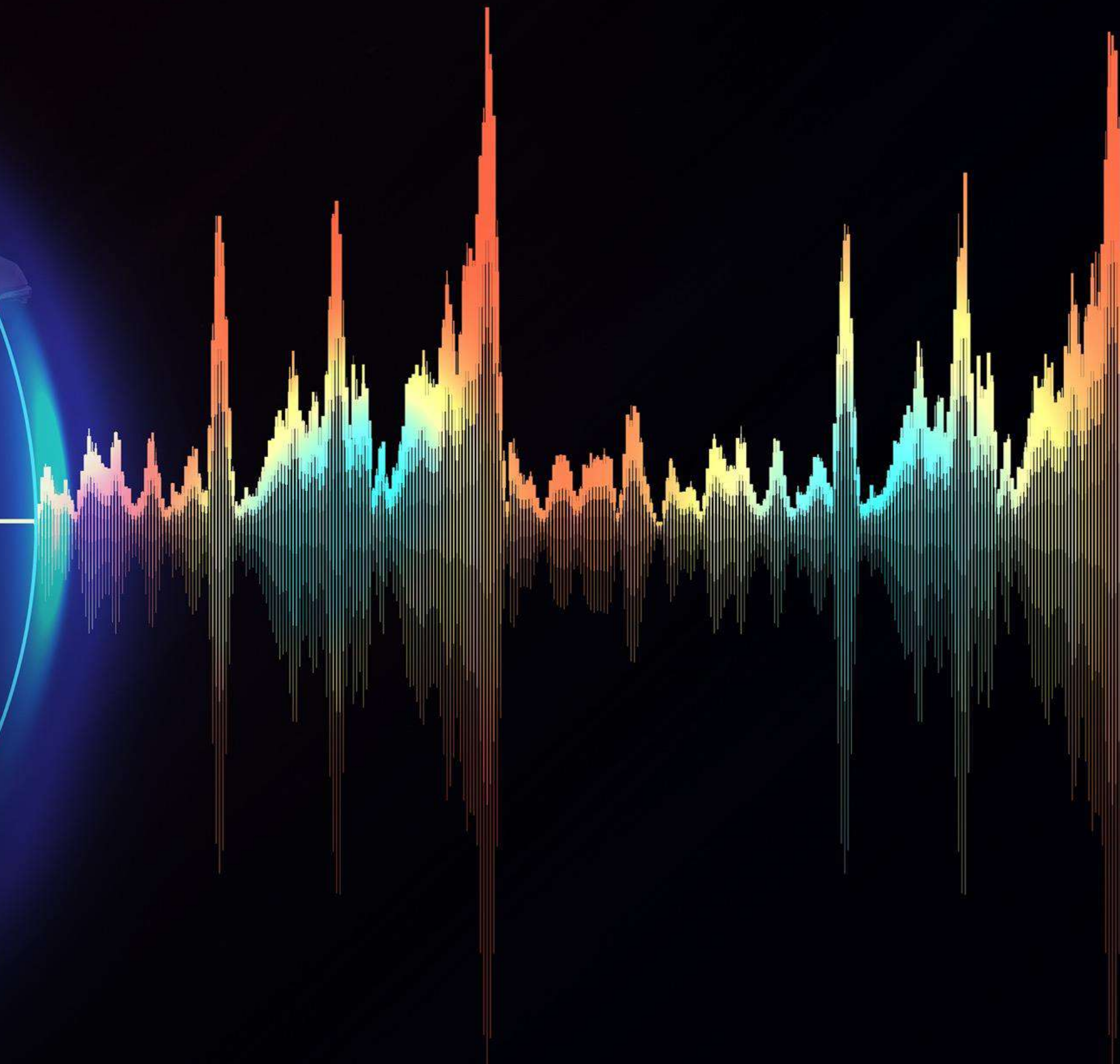

10m Turning circle diameter and Best Maneuverability



Best in class TCD & Lock to Lock angle

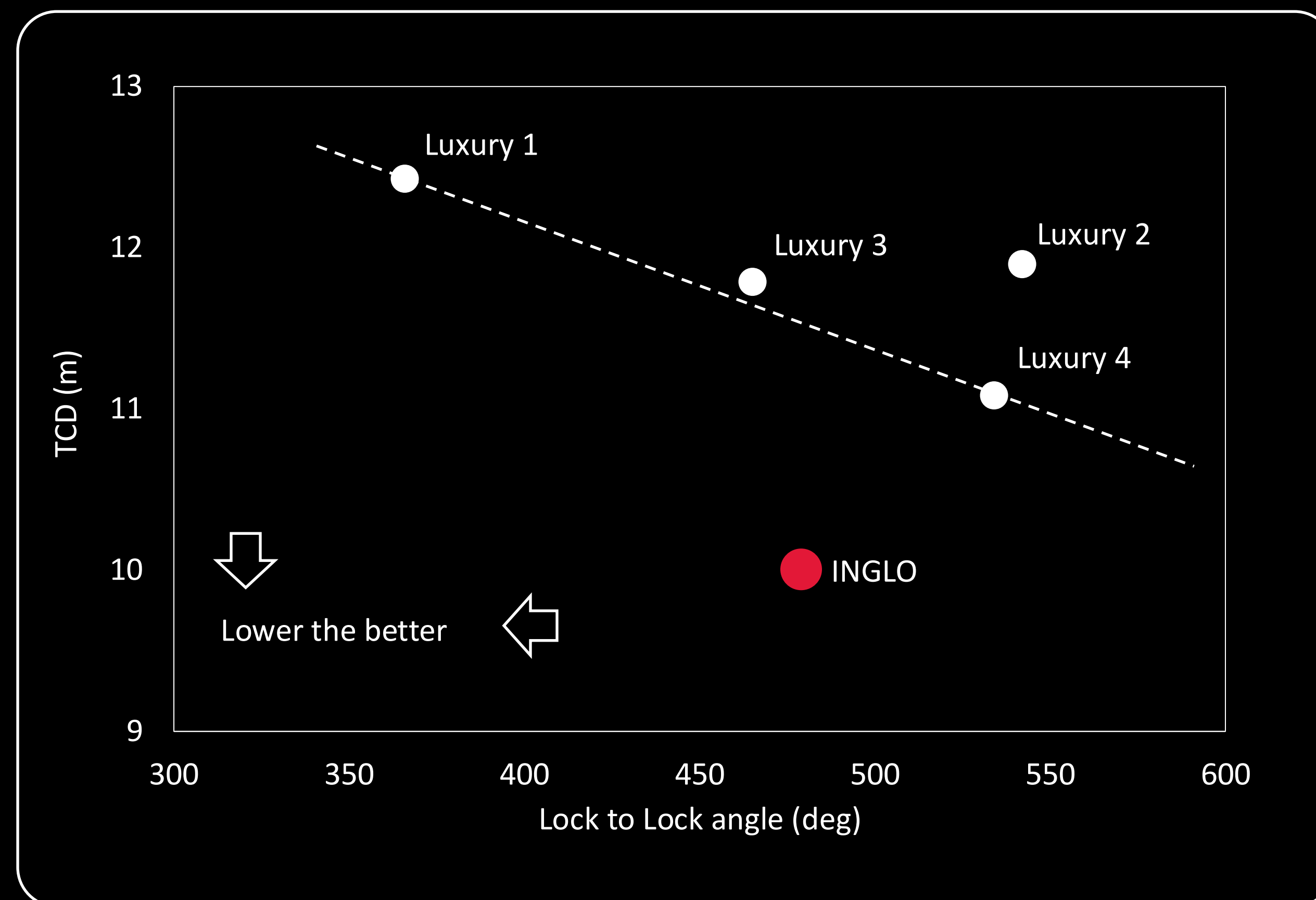

Lowest steering efforts during parking – Normalised values in %



Powerful & Intelligent brakes

Time to lock

200_{ms}

Range benefit*

18%

Value added functions

46+

BLAC motor

800_w

100 to 0 kmph in 40 meters

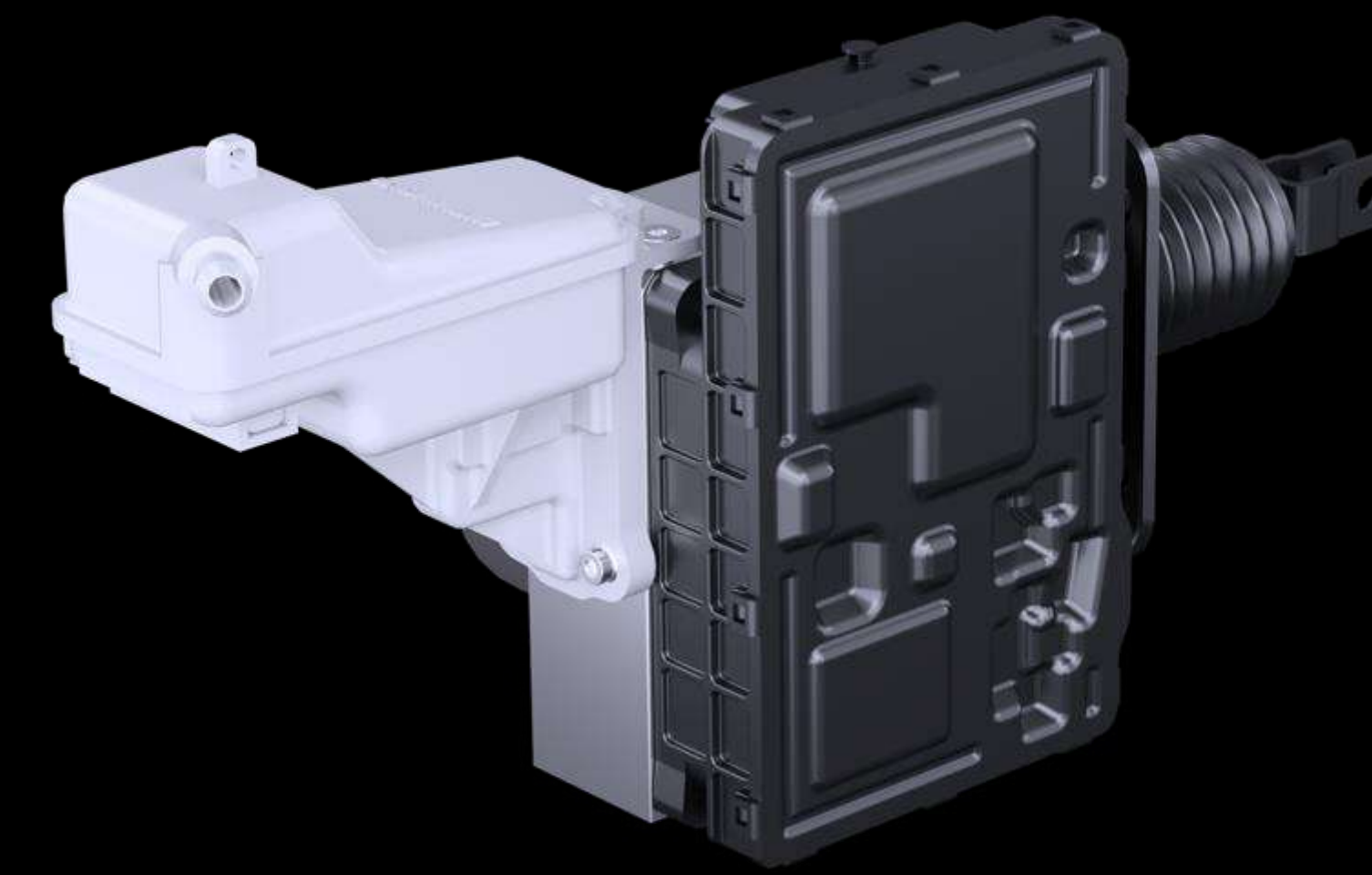

Integrated Electronic Booster (IEB)

Brake by wire



*Upto 18% benefit by maximizing recuperation potential

Protection with maximum filtration of UV rays

200- 400 nm UV rays are filtered to

99.5%

☐ Windshield glass

☐ Roof glass

☐ Side glass

Source : Inhouse measurements

- Health
- Comfort
- Range (AC ON condition)



The fastest to cool with the purest air quality

Highest cabin airflow

535 m³/hr

Smart Air Purifier*

VR LED

PM 2.5 sensor

AQI

(Air quality Index)

Activated Carbon Filter

95 %

(PM2.5 filtration efficiency)

* VR LED – Visible Ray Light Emitting Diode 470 nm wavelength.
Neutralizes microbes and odour

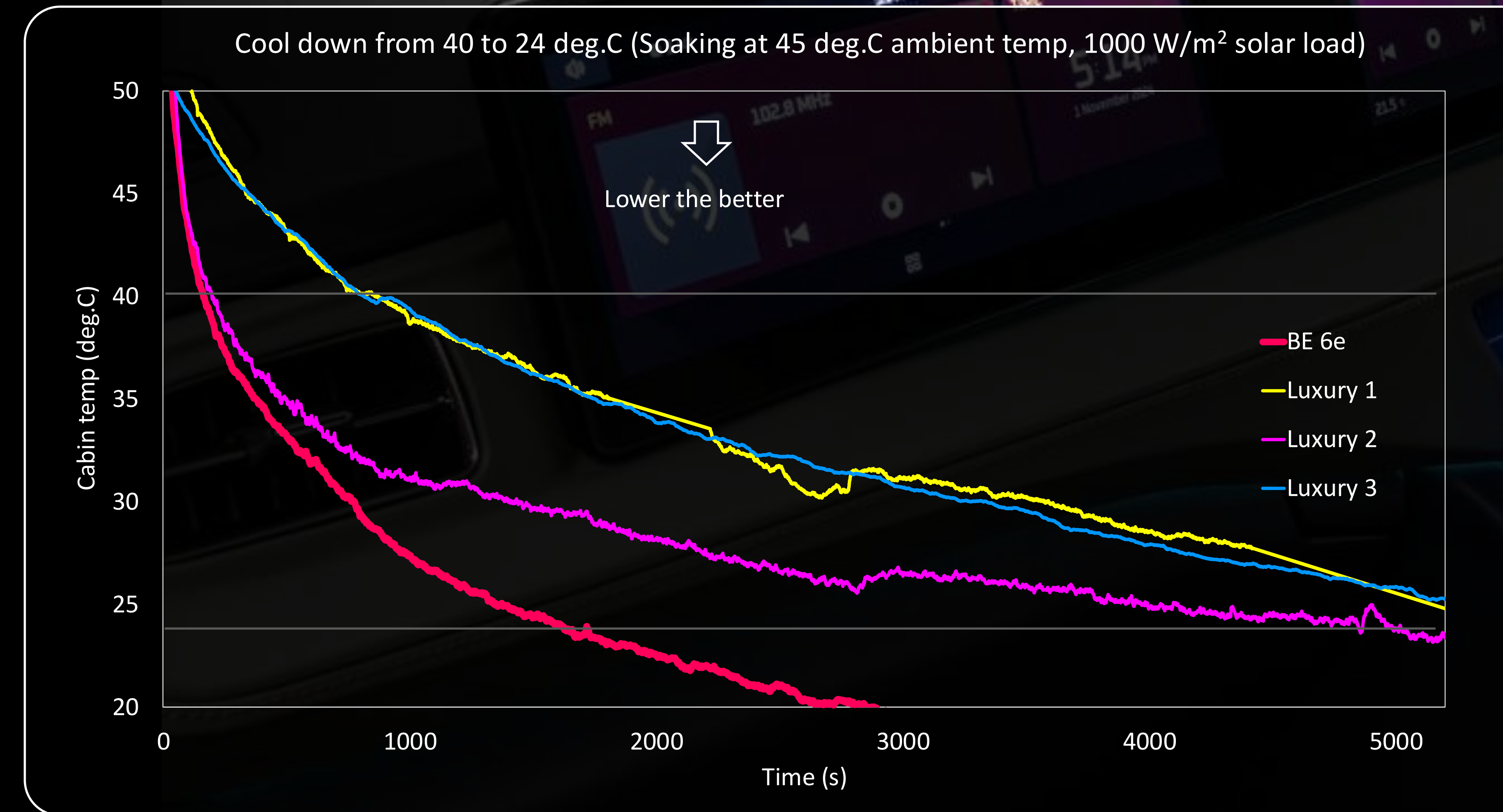

Source : Inhouse measurements

7 airbags with the reinforced BIW structure

Frontal crash protection

30 g **peak deceleration**

400 kJ **impact energy**



Side crash protection

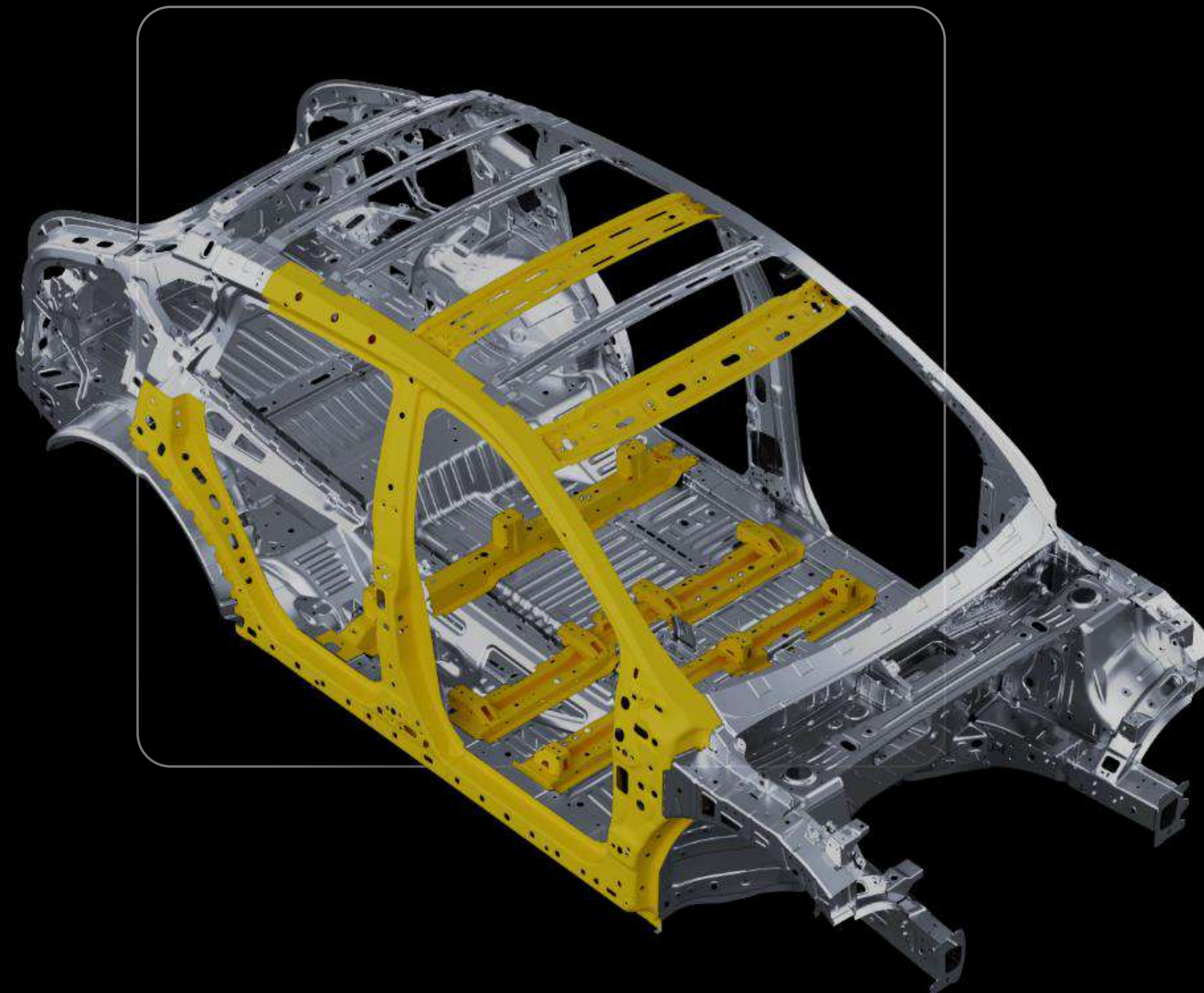

7 airbags, 3 point ELR



ELR = Emergency Locking Retractor

Break-through Battery Technology with 35 patents*

Advanced LFP Blade Cell

79 & 59 kWh

Best-in-class LFP Energy Density

141.5 Wh/kg

High Efficiency

400 to 465 V

Cell to pack technology

Compact Lean Module

Bottom Transverse Cooling

Nail Penetration Robustness

* Patents applied

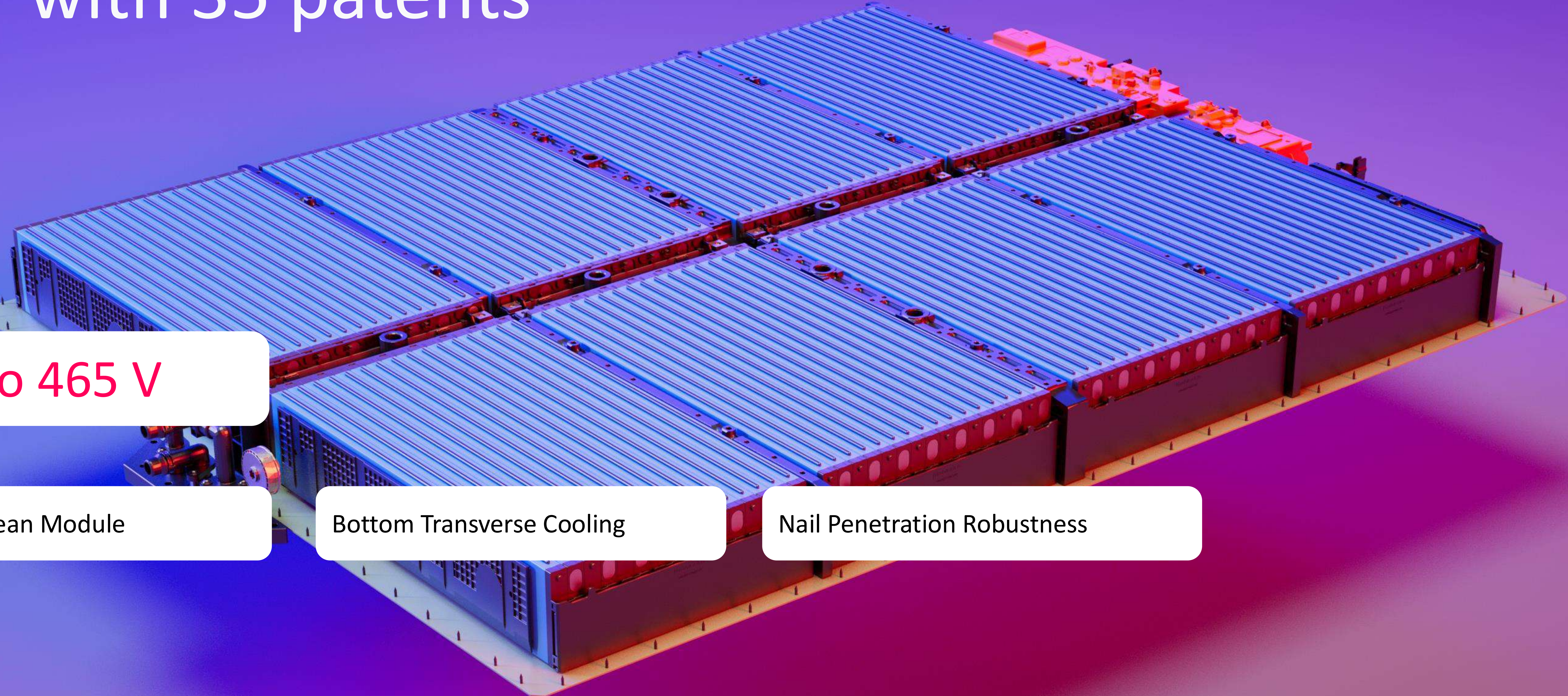

Impressive Range in Regulatory Cycles

79 kWh

Range (km)

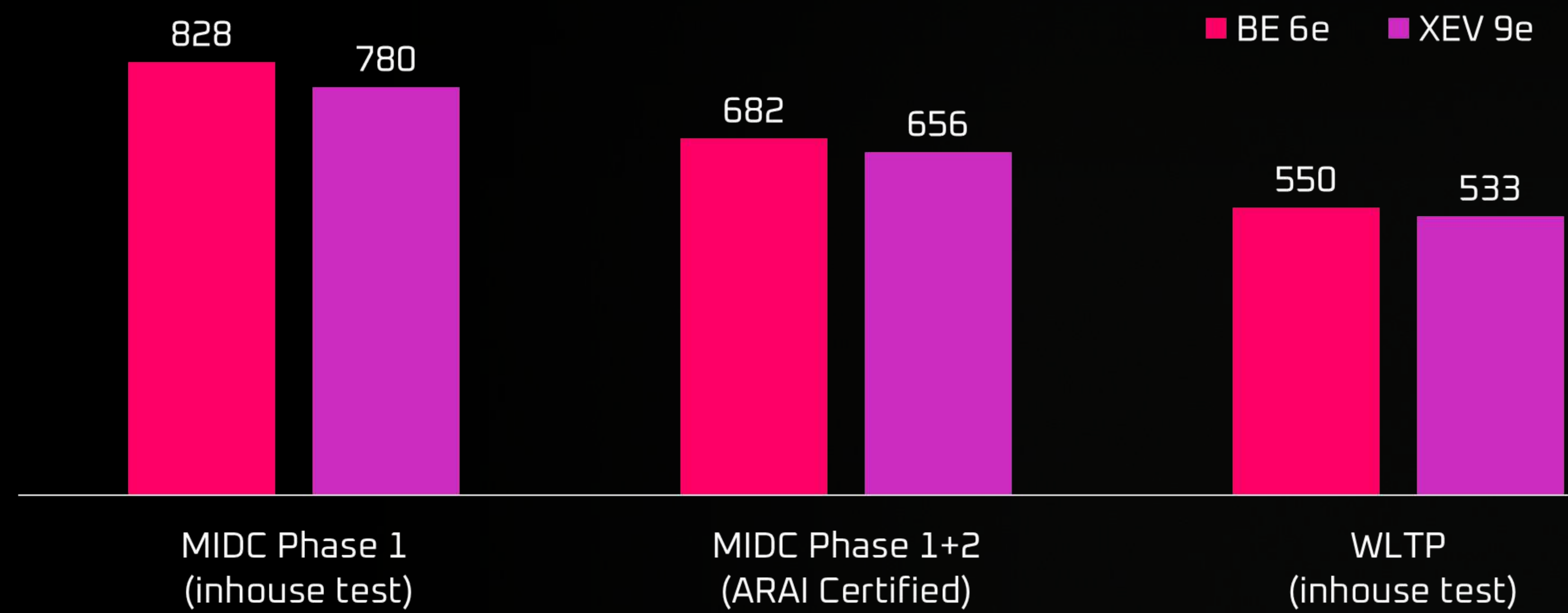

500+ km Real Range in metros with AC ON (79 kWh)

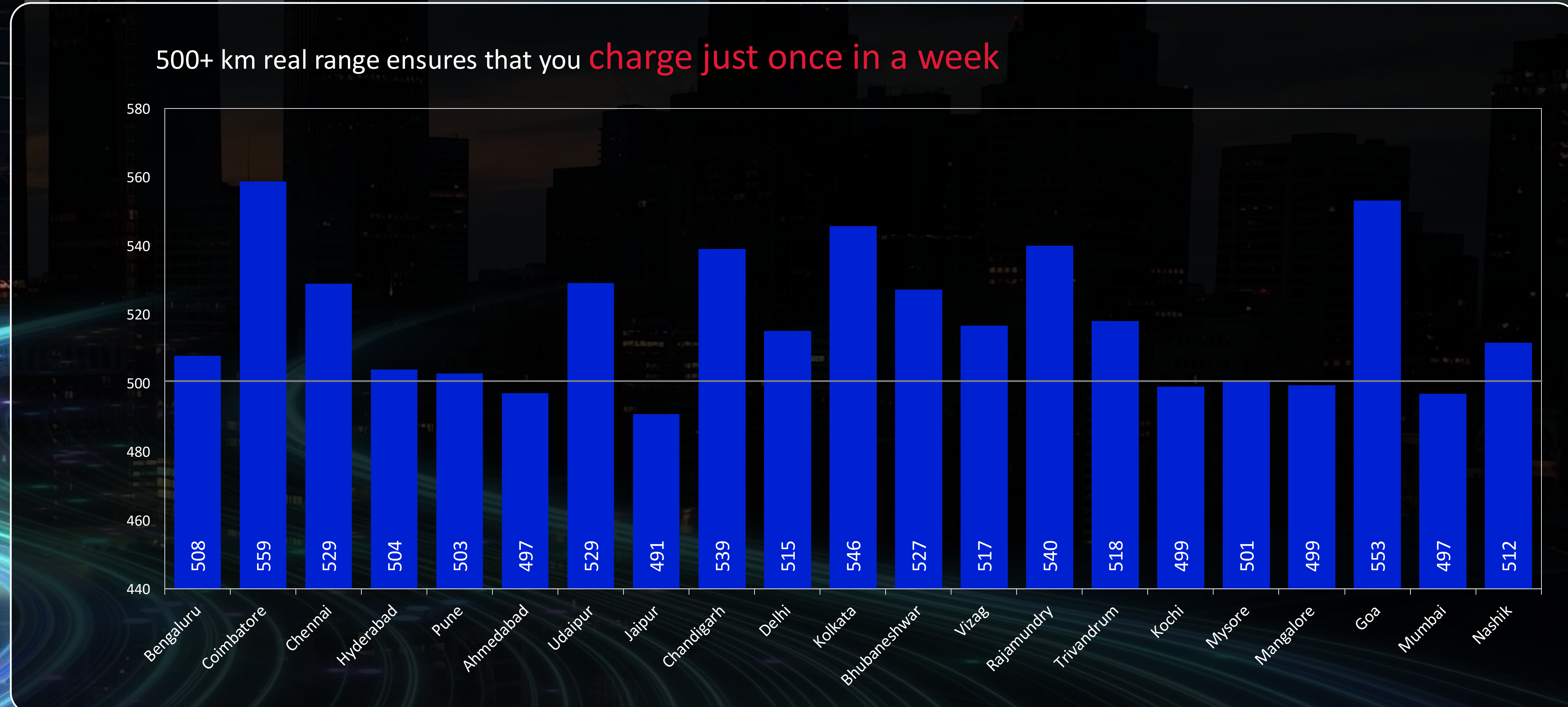

Fast-charge from 20% to 80% in just 20 mins*

~ 20% to 80% in 20 mins*

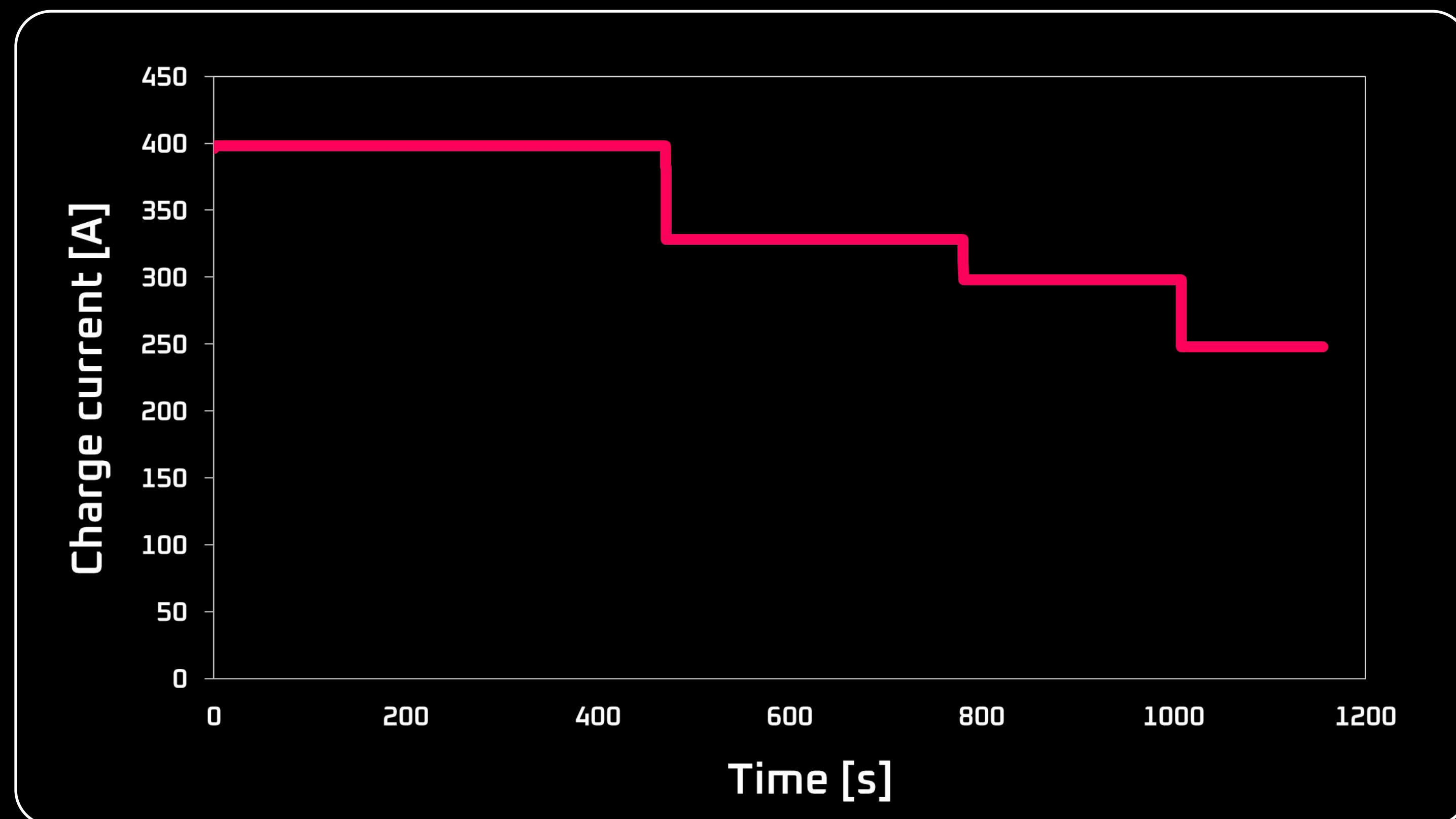

*175 kW DC Fast Charger

Charge points validated

1600

Charge events completed

16,260

Battery robustness 14,577 hours and 55+ lakh kms

HV safety

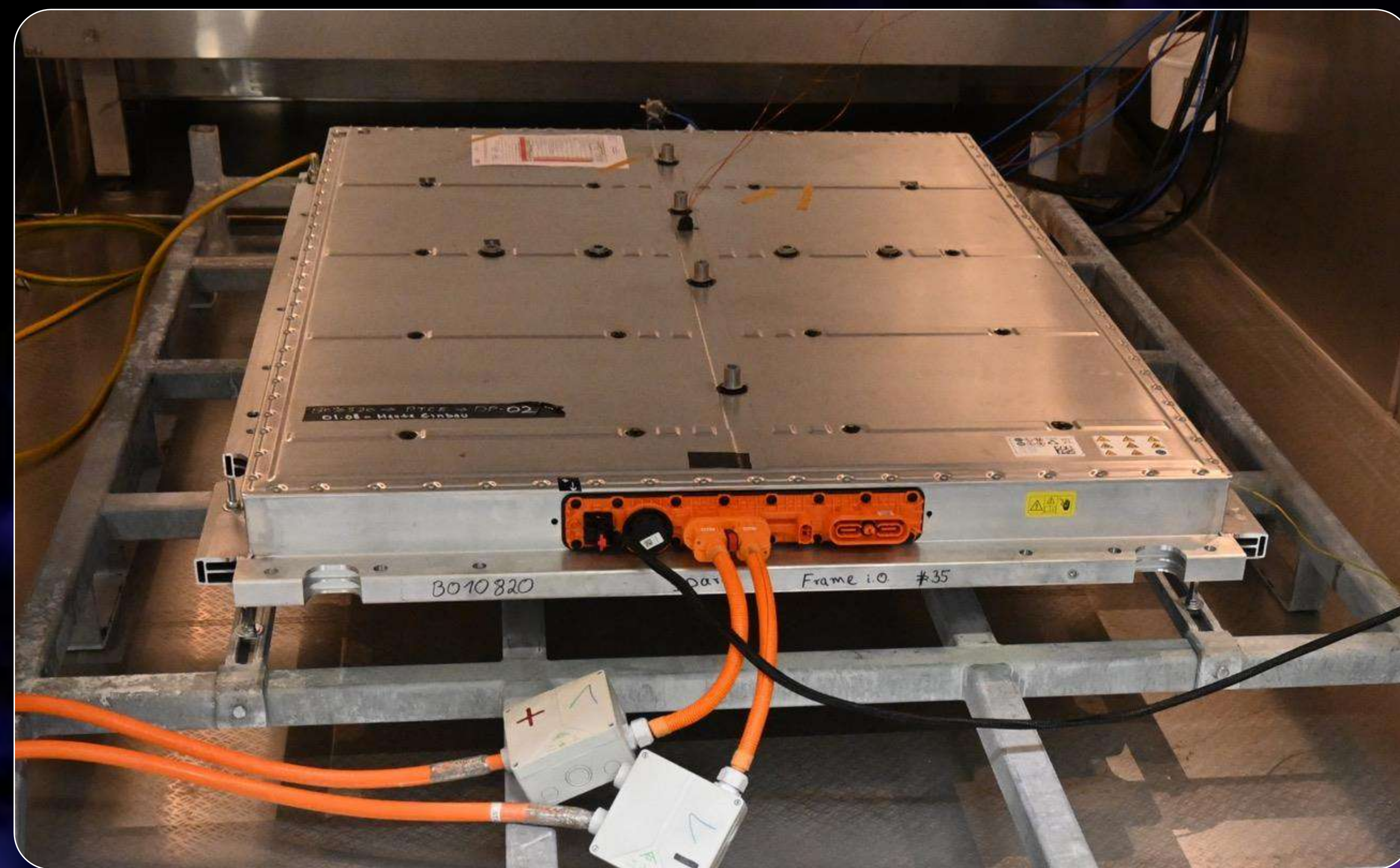

Water leakage



Thermal



Vibration

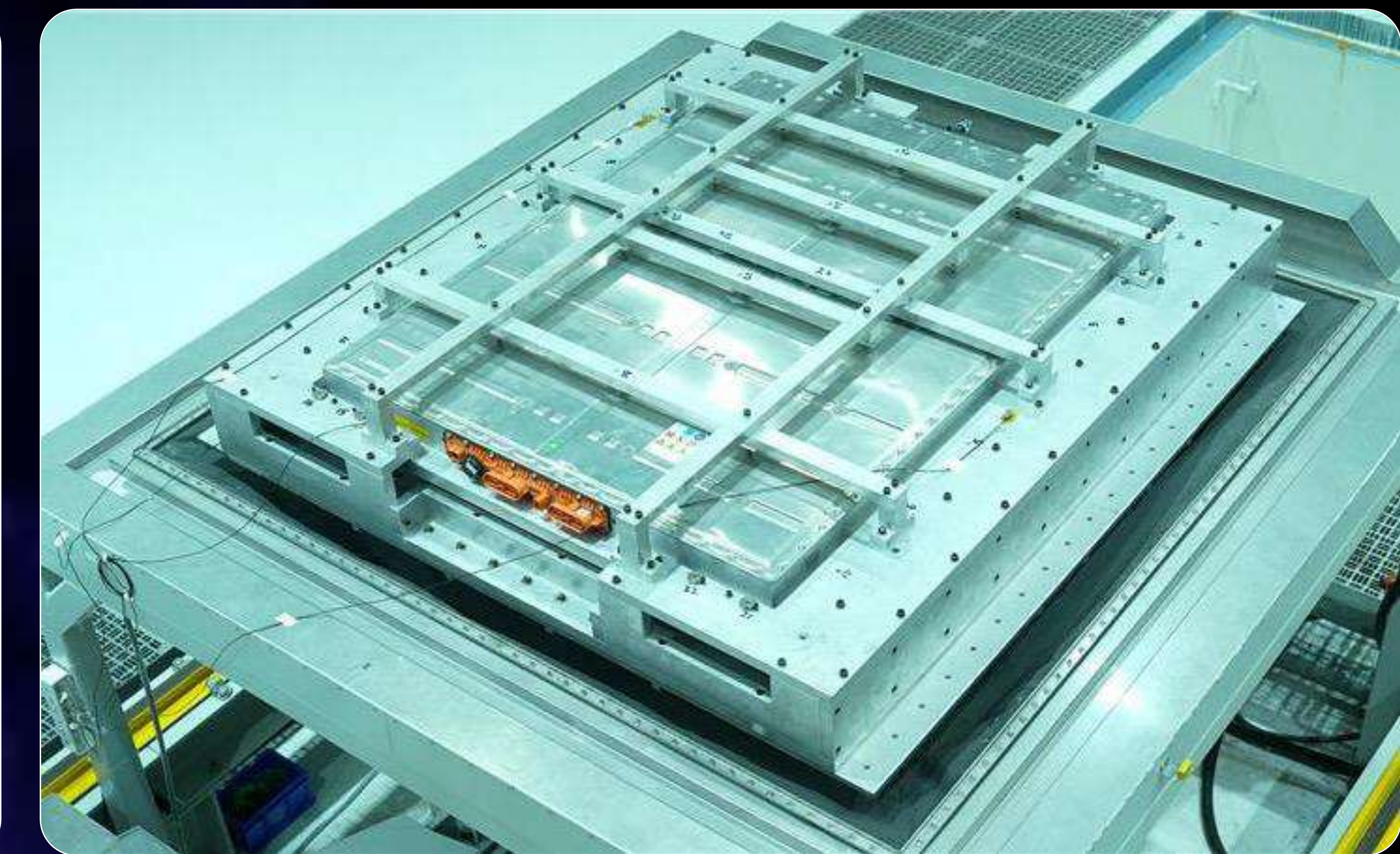



CRUSH TEST 20 ton

Regulation : 10 ton

IMMERSION TEST 30
min

The background features a series of vibrant, glowing lines in shades of red, pink, and blue. These lines are curved and wavy, creating a sense of motion and energy. They are set against a solid black background, which makes the colors stand out prominently. The lines appear to be layered, with some being thicker and more intense than others, giving the overall effect a dynamic and futuristic feel.

VIBRATION TEST

Random vibration: 8 g
Shock load : 30 - 50 g



FIRE RESISTANCE
3 MIN

Flame temperature
800 - 900 deg.C

World-class Battery – Life-time warranty*

Stable SOH over lifetime charge and discharge cycles

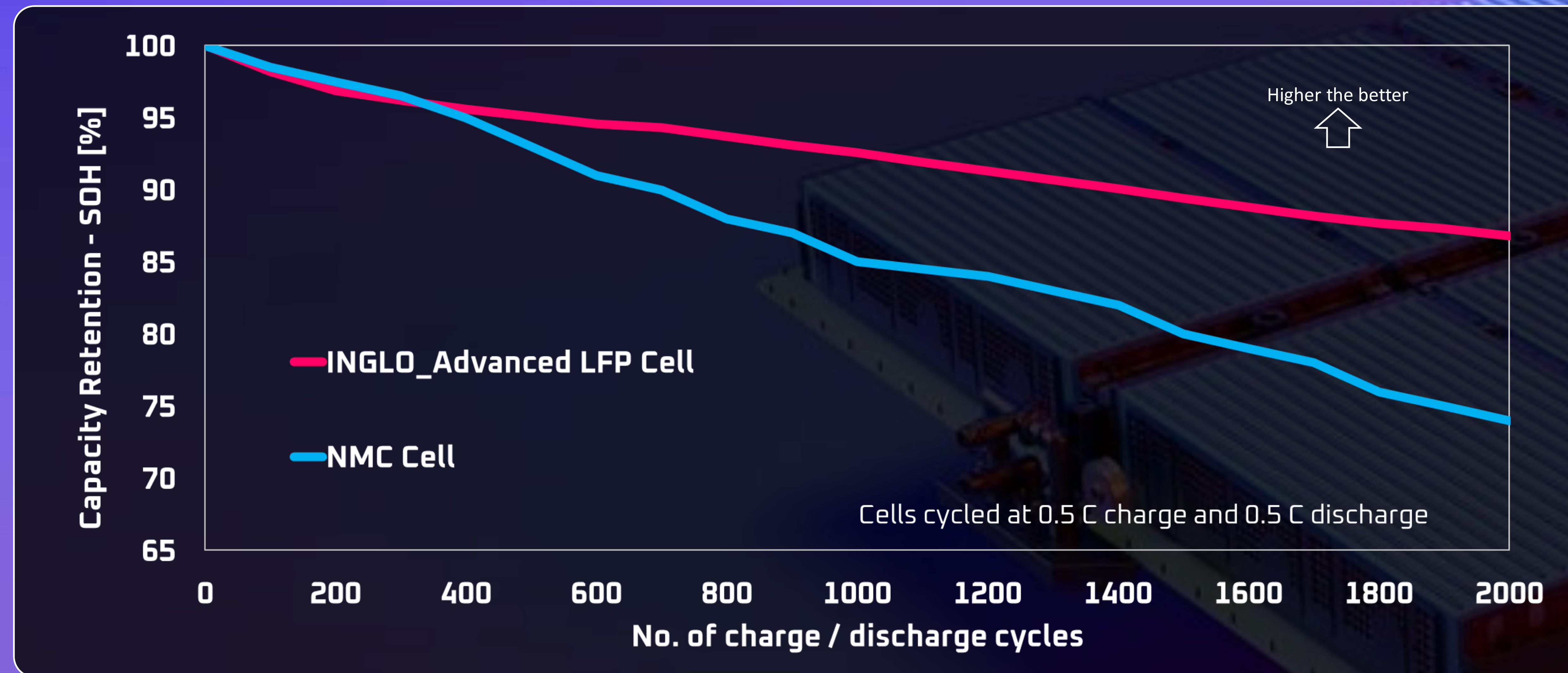

*For First Registered Owner. Applicable for Private Registration only.
In case of ownership change, warranty on HV Battery shall be 10 years or 200,000 km, whichever is earlier from the first ever date of delivery of the vehicle.
Full Details will be available at the time of Bookings' commencement.

Unmatched performance

Compact 3 in 1 powertrain

210 kW

380 Nm

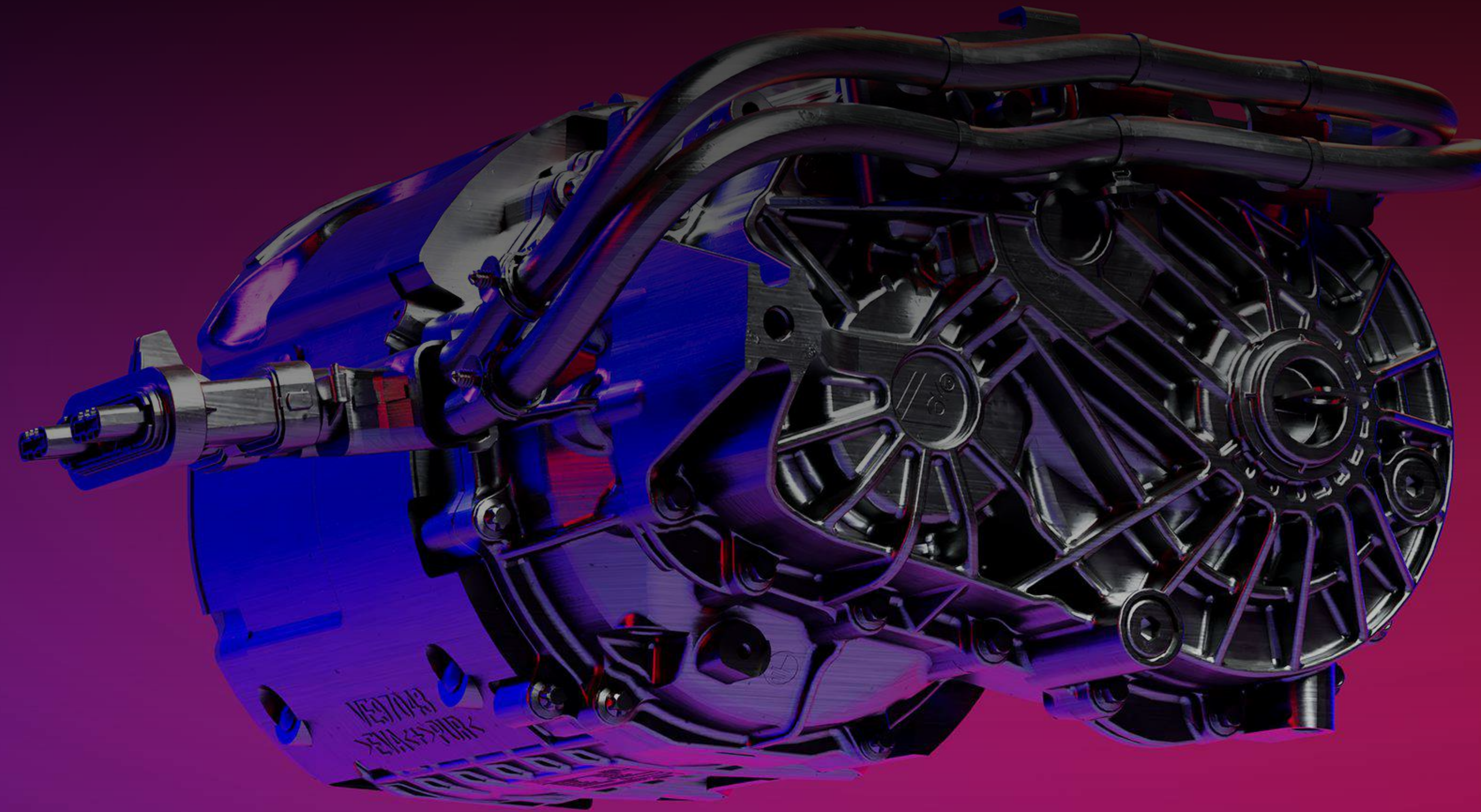

Best-in-class Power Density

2.0 kW/kg

0 to 100 km/h in just 6.7 seconds

Model	0 -100 sec
XEV 9e	6.8
Luxury 1	7.1
Luxury 2	6.3
Luxury 3	6.1
Luxury 4	8.2
BE 6e	6.7
Best ICE	10.0

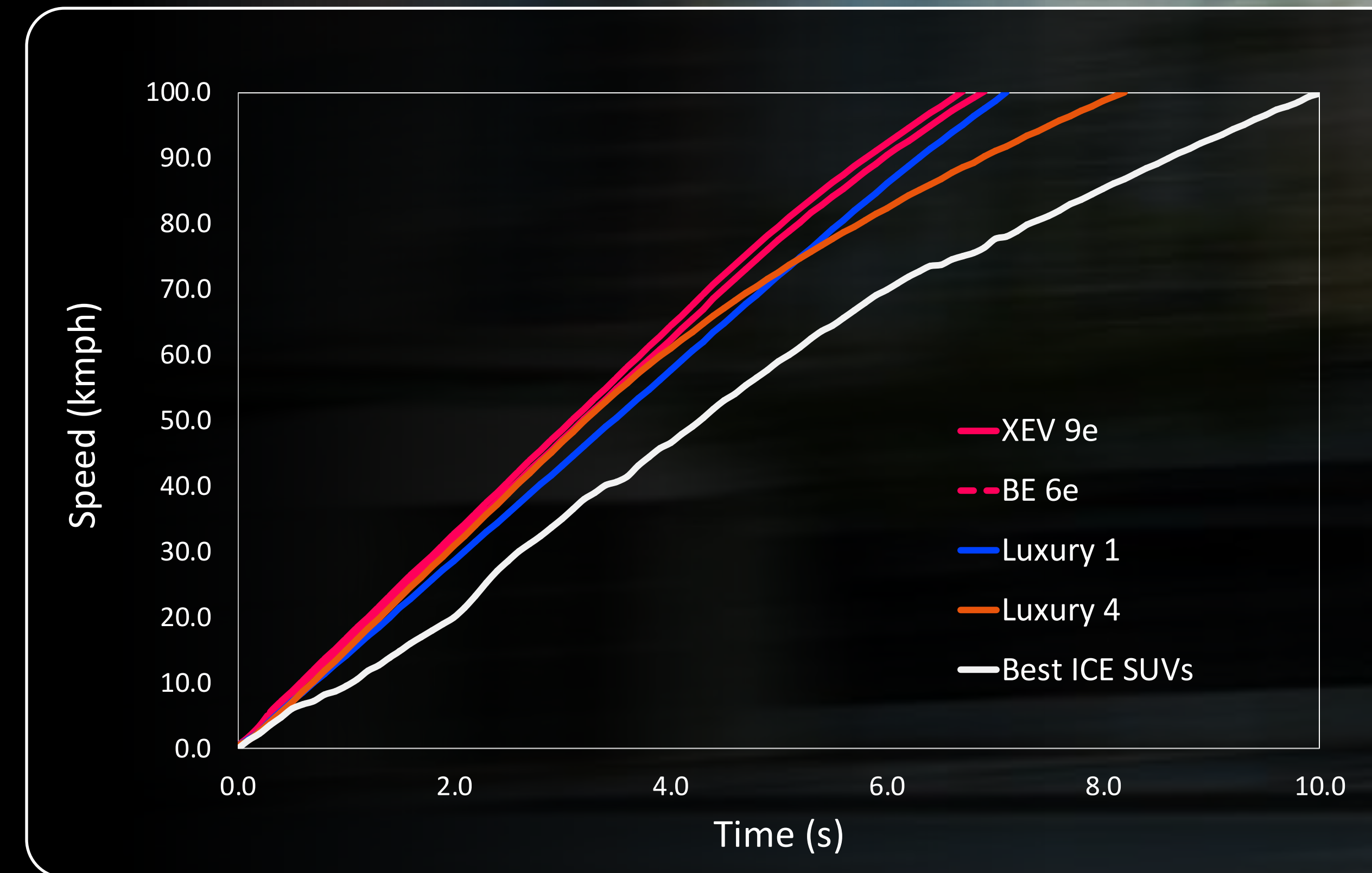

Source : Inhouse measurements





MAAIA

Mahindra Artificial Intelligence Architecture

Our vision was to create a 'WOW' through 'SOW'

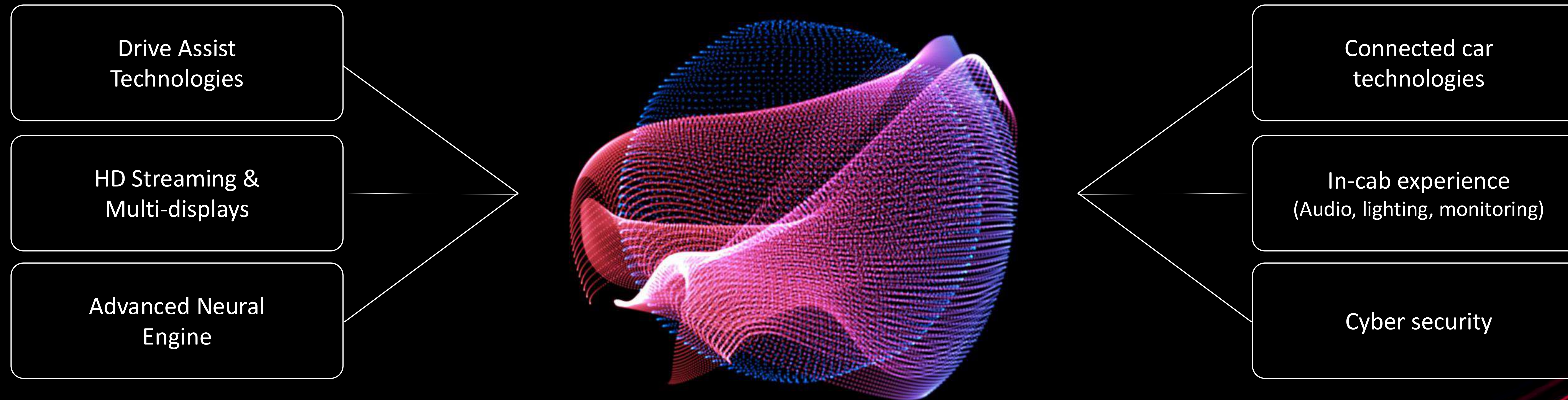

SOW = Software On Wheels

MAIA – Mastermind of Software Defined Vehicle (SDV)

Software

- Cloud
- Applications
Services
UI/UX
- Car OS
Middleware
Platform software
- Platform hardware

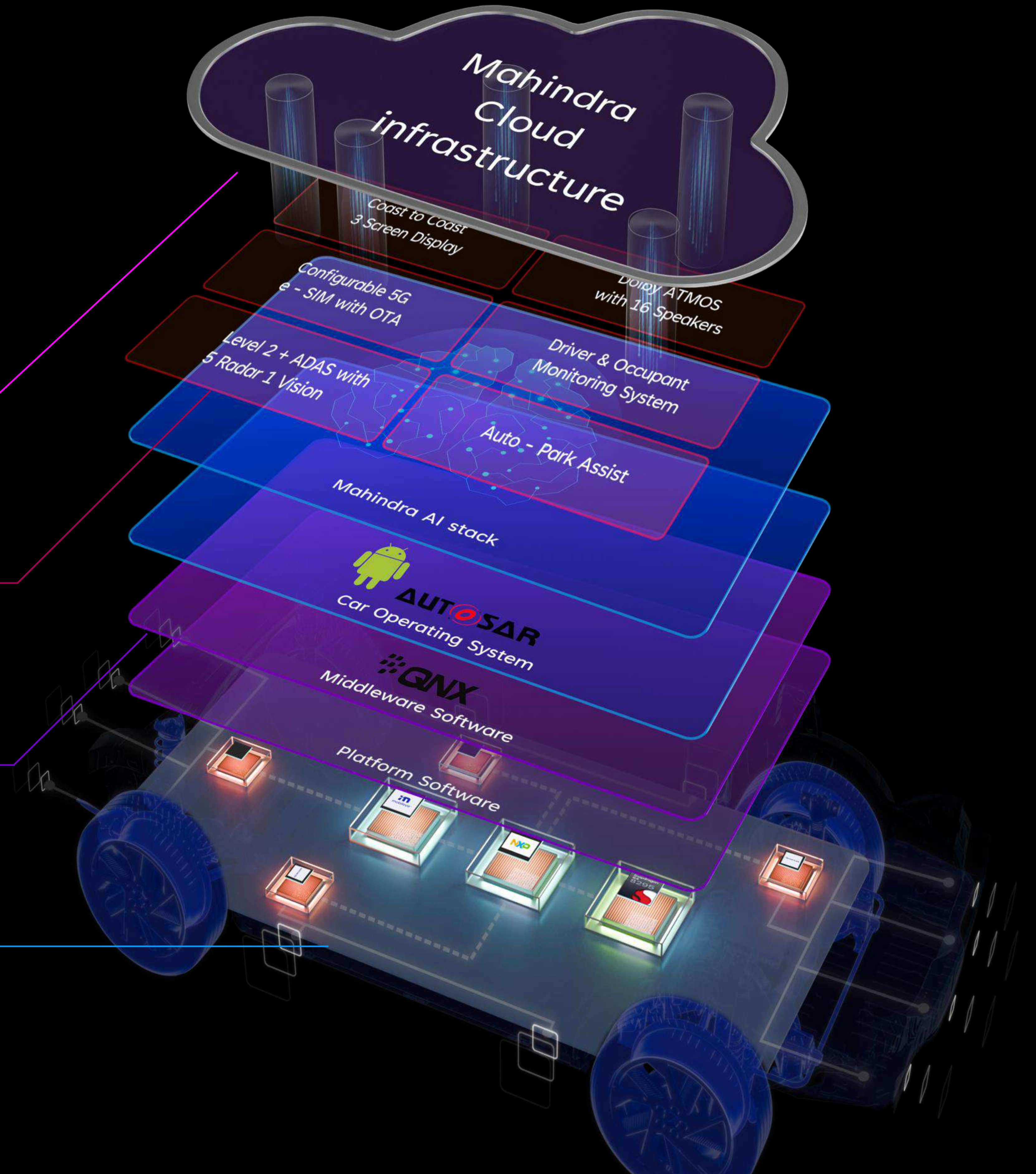

The Advanced Software Architecture of MAIA

Typical Distributed Architecture

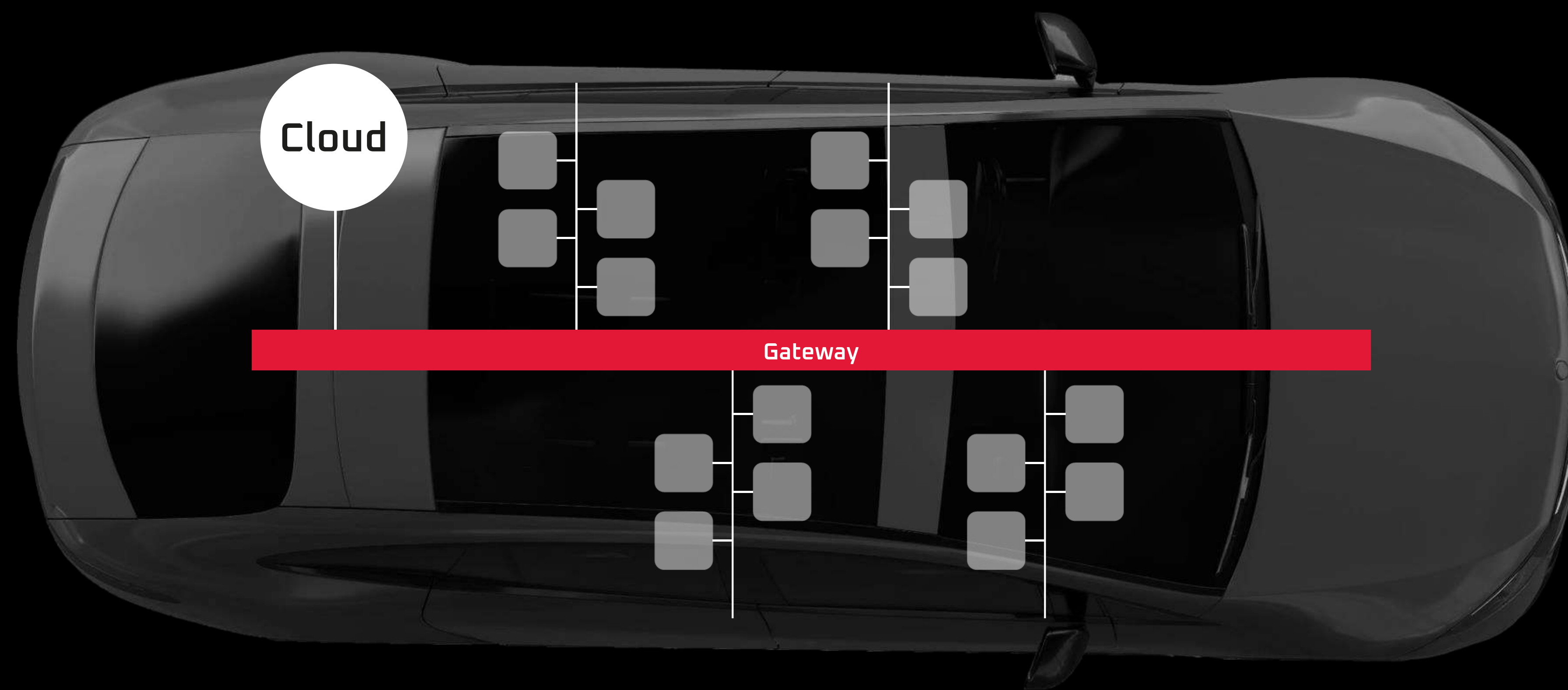

MAIA: Domain Architecture

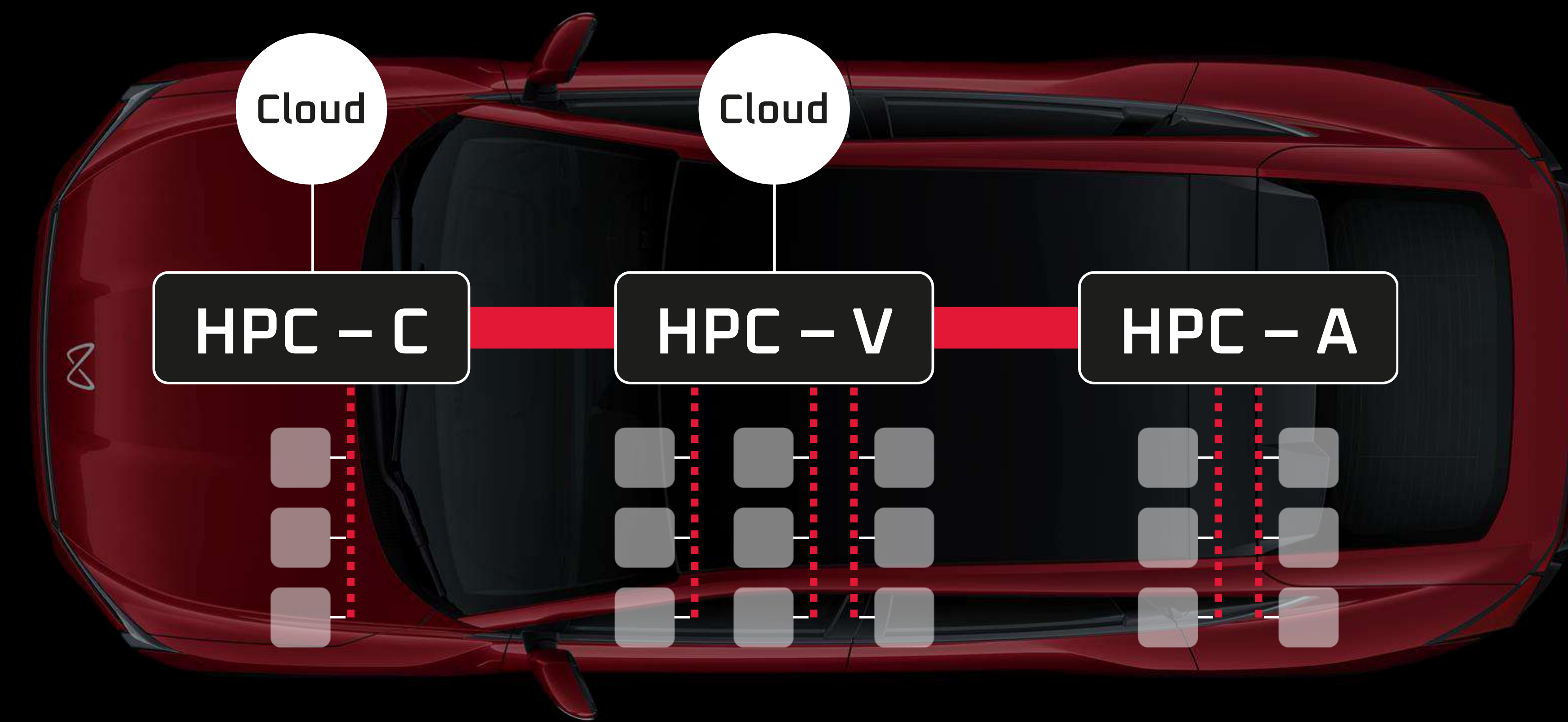

Ethernet Backbone — CAN FD — CAN / LIN —

MAIA – The most powerful mind in the automotive world

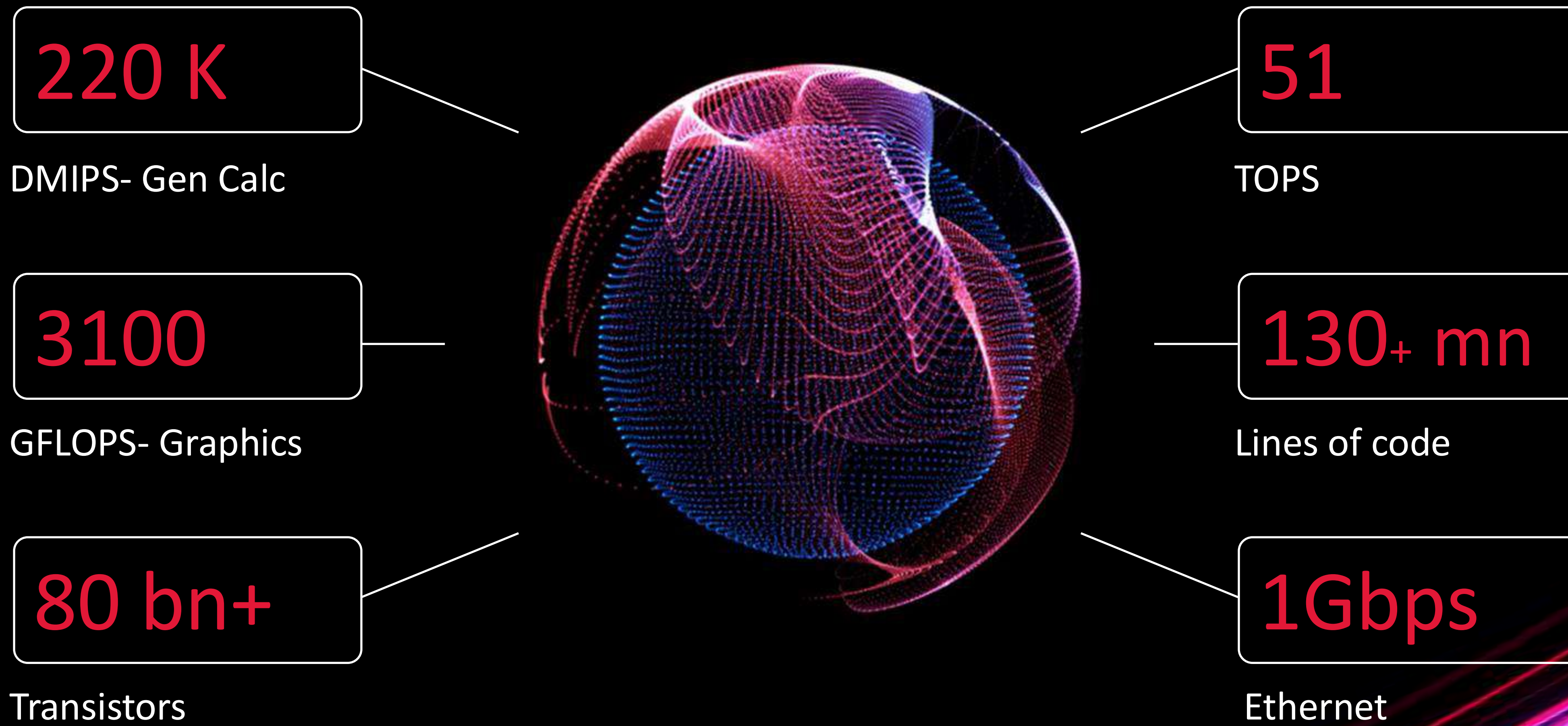
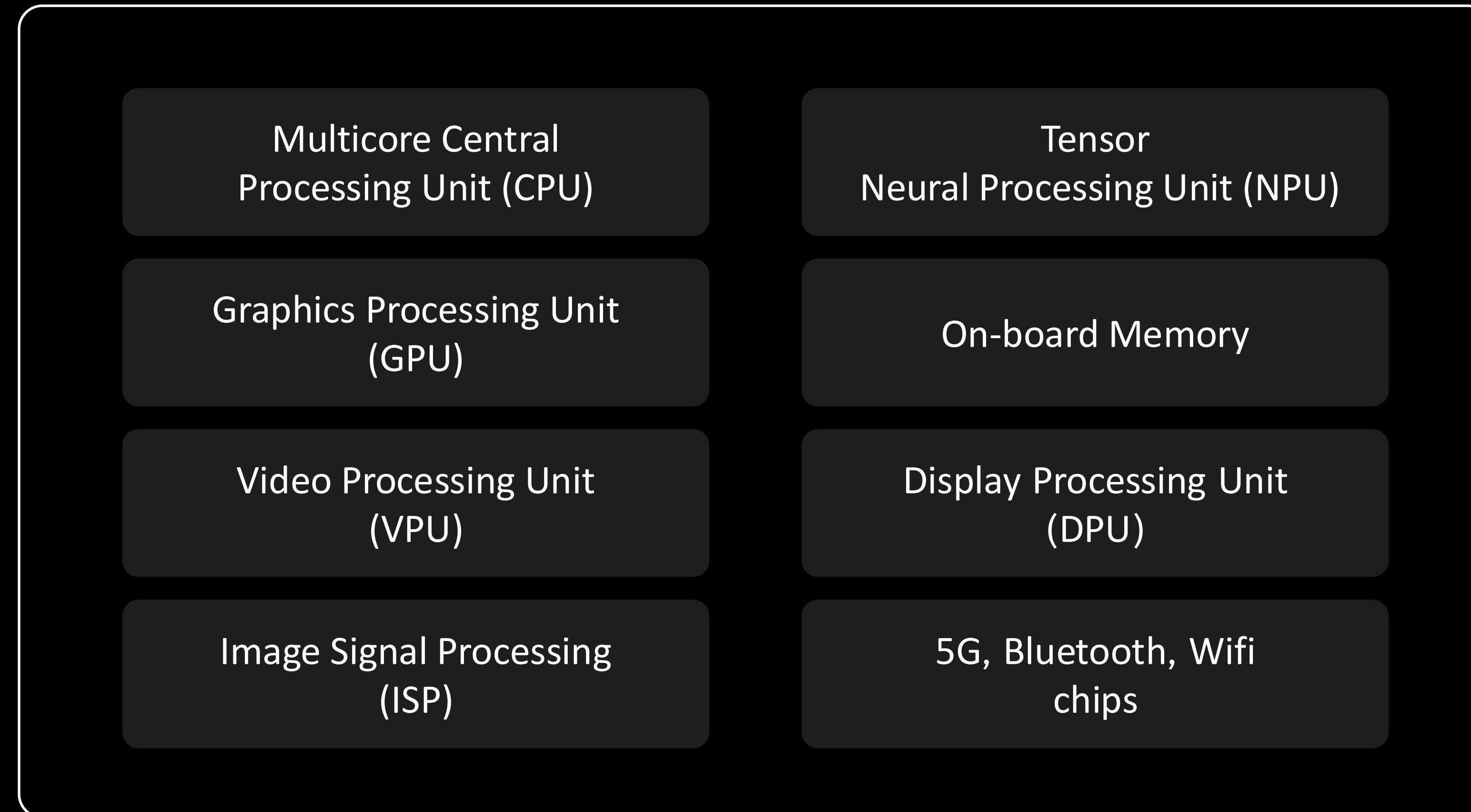

MAIA – The most powerful mind even in the mobile world



Processor	MAIA	Luxury Phone*
CPU	220K DMIPS	110K DMIPS
GPU	3100 GFLOPS	2227 GFLOPS
NPU	51 TOPS	35 TOPS

*As per information available in public domain

The most powerful cockpit SoC in Automotive world

Qualcomm SA 8295

DMIPS

200 K

TOPS

46

GFLOPS

3000

Process node

5 nm

Snapdragon
Cockpit

SoC = System on Chip

Entertainment & Connected Hub

Graphical Processing Unit

6th Gen ADRENO

Cloud

AWS

Connectivity – 2.4 Gbps

QUECTEL 5G

Connectivity – 2.4 Gbps

WiFi 6.0, BT 5.2

Modern gaming engines

Seamless access to music & movies

16 Speaker HK, Dolby Atmos

5G, CV2X*, Funbox, Secure 360, BYOD

* subject to regulatory approval

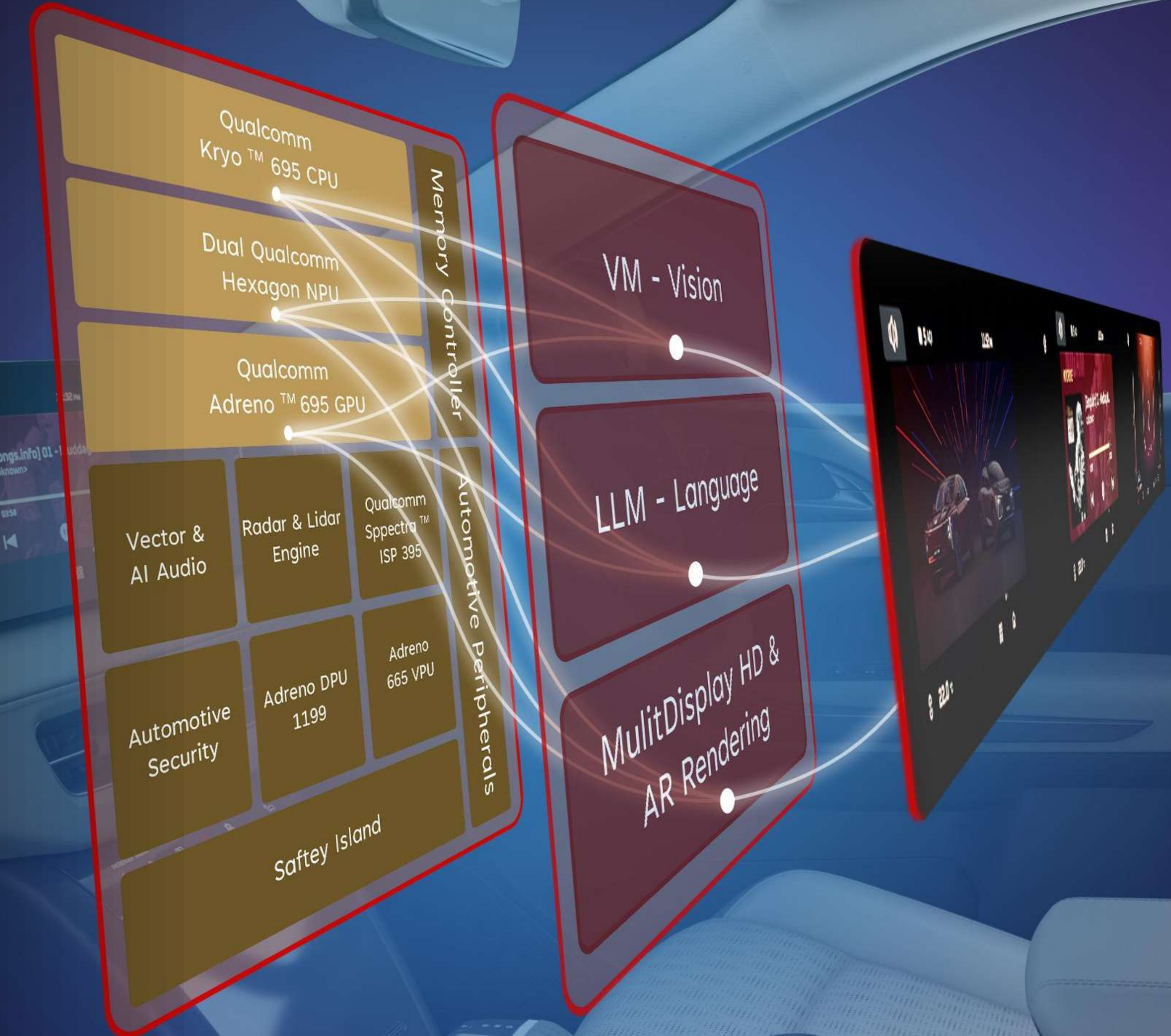

Advanced AI suite

Driver assist

EyeQ®6 Mobileye

Park assist

TI TDA2

Cabin Monitoring, voice engine, Augmented Reality

Qualcomm 8295

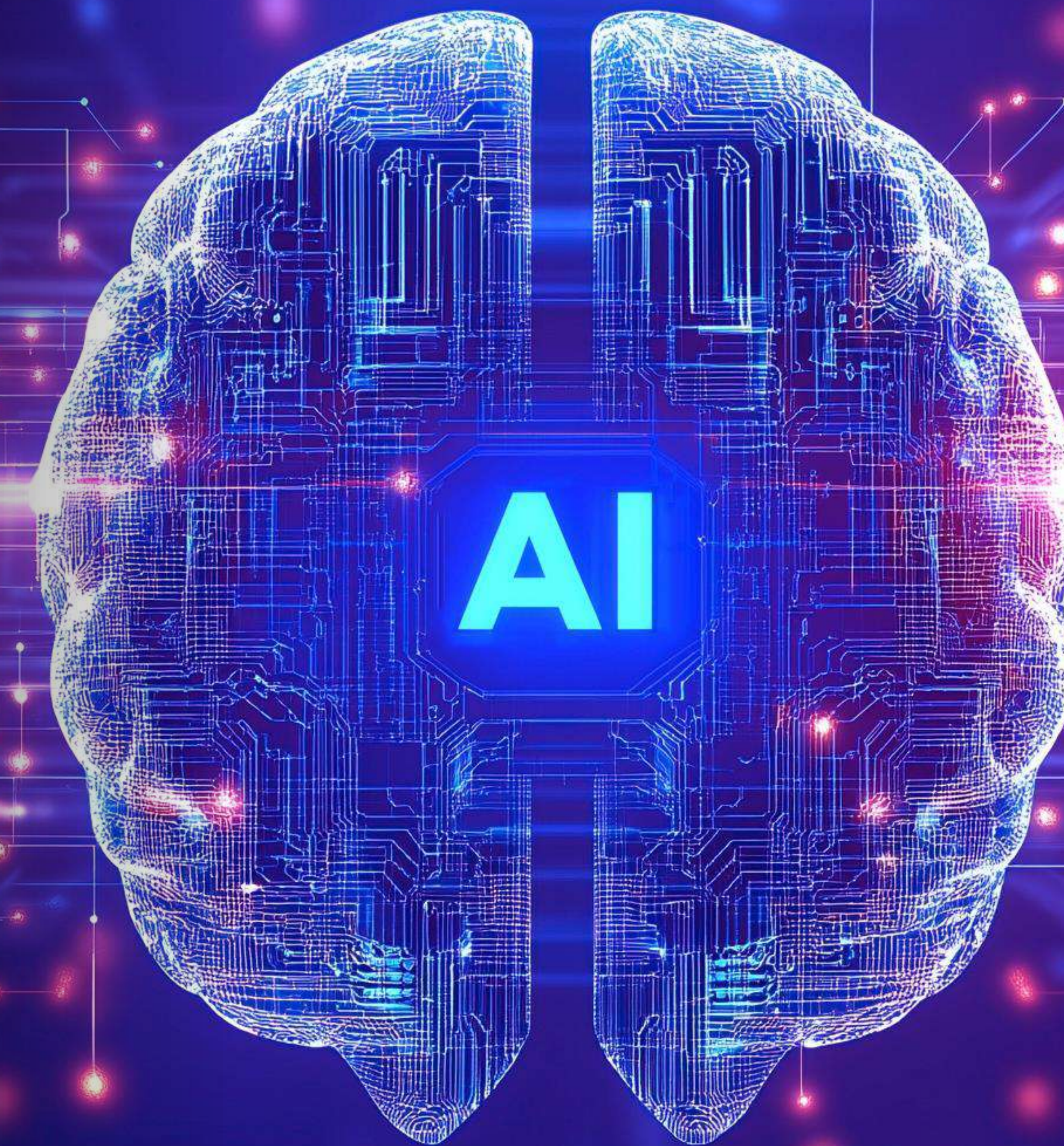



MAHINDRA SONIC STUDIO

Mahindra Sonic Studio Experience

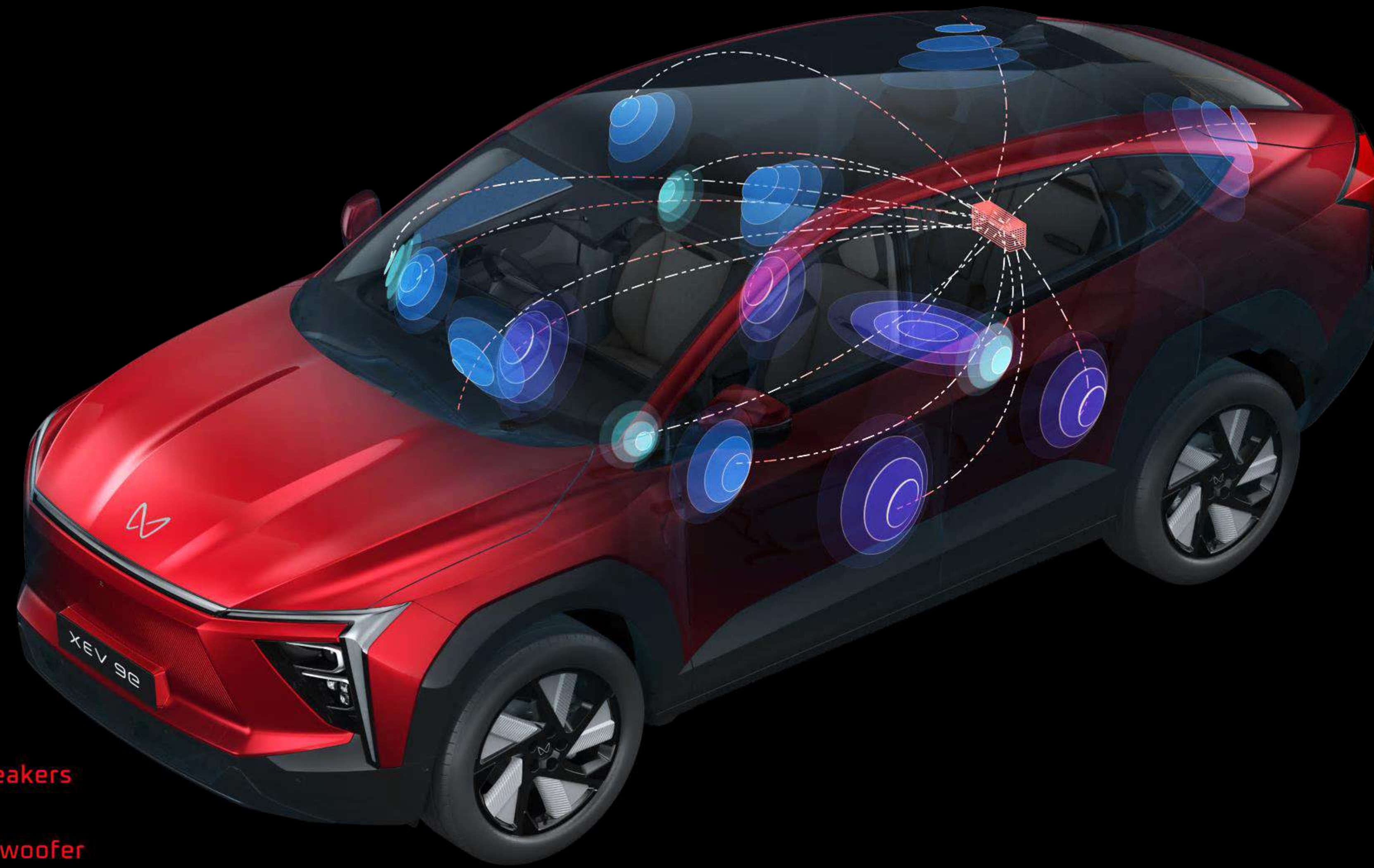

- Mid Range Speakers
- Tweeters
- Woofers / Subwoofer
- Amplifier

16 High performance speakers

15 Channel Amplifier

1400 Watts

Spectral Balance











Spatial Envelope

QuantumLogic Immersion

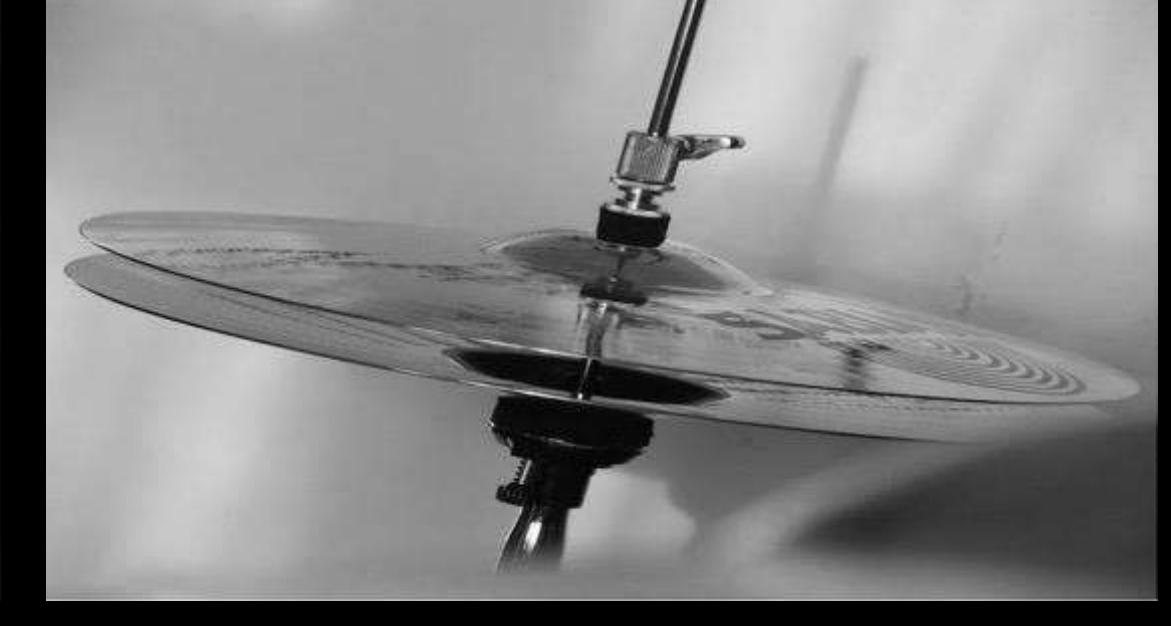
VenueScapes (LIVE)

Dolby Atmos

Audio Frequencies in Music

Sub-bass	Bass	Mid		Treble	
Adds rumble and power; felt more than heard	Provides Power & foundational energy	Adds warmth, definition & clarity, to vocals & instruments		Adds Sparkle & Air	
20-60 Hz	60-250 Hz	250 Hz – 6 kHz		Presence 6 – 10 kHz	Brilliance 10 – 20 kHz
					
					

Mahindra Sonic Studio with QLI & DOLBY ATMOS

Parameter	Luxury 1	Luxury 2	Luxury 3	Luxury 4	XEV 9e & BE 6e
Sound system	14 speaker Inhouse brand	16 speaker Harman Kardon	16 speaker Bang & Olufsen	12 speaker Burmester	16 Speaker Harman Kardon
Dolby Atmos	No	No	No	Yes	Yes
3D Sound	Yes (Immersive)	No (Surround)	Yes (Surround)	No (Surround)	Yes (QLI immersive)

BE 6E / XEV 9E

Top 10 Hero Experiences



LOVE EXPANDS PERSPECTIVE

Experience the 110cm wide Cinemascope



Entertainment, Games, Office
BYOD In-car Experience

Vehicle Controls and Key Features
Omni-present Bottom Bar & Customization

Crucial Info and Stats
Navigation & ADAS View

LOVE GETS THE HEART RACING

Race-Ready Digital Cockpit



LOVE IS ALWAYS IN YOUR LINE OF SIGHT

Augment your Reality with VisionX



500 m
Kalyani Na...



50 50
km/h



Kala chashma
02:36

LOVE LIGHTS UP YOUR WORLD

16 million hues in the sky,
all yours with the **Infinity
Roof**



EVERY BEAT A HEARTBEAT

16 Speaker
Harman Kardon
with Dolby Atmos

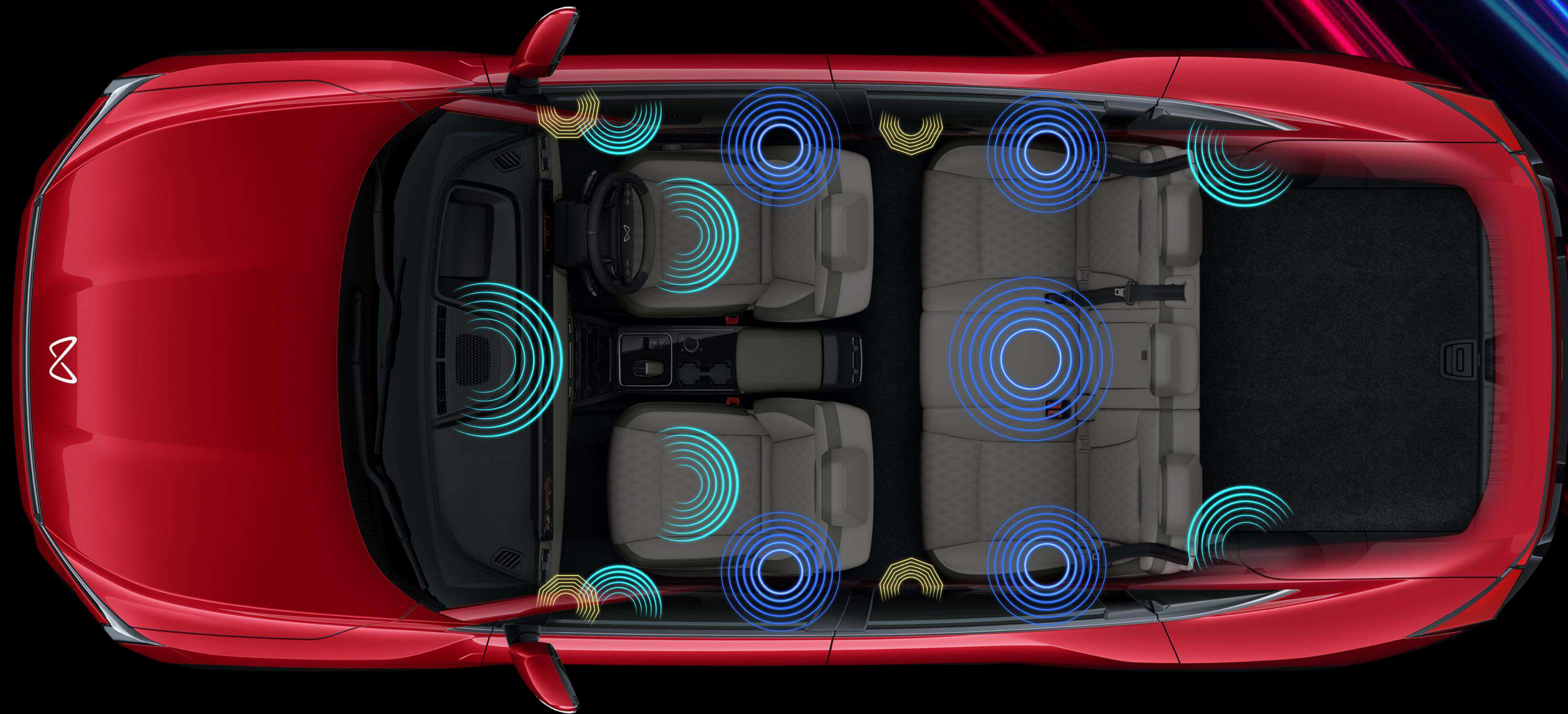

LOVE LETS YOU BE

LiveYourMood - Cozy, Calm & Club

12:36 PM

TIME
31 September 2099

BLUETOOTH
Track name
Artist

ENERGY 40 %
Last charge
20 min +30 % +80 km
Charge now

12:36 PM 042 AQI Profile

BLUETOOTH
Track name
Artist

OXFORD STREET
Work
Chargers
Search

22.0 °C

12:36 PM 29 °C

120 km/h

280 km RANGE 50 %

EVERYDAY 19223 km

75 % L3 POWER

LOVE LETS YOU BE

LiveYourMood - Cozy, Calm & Club

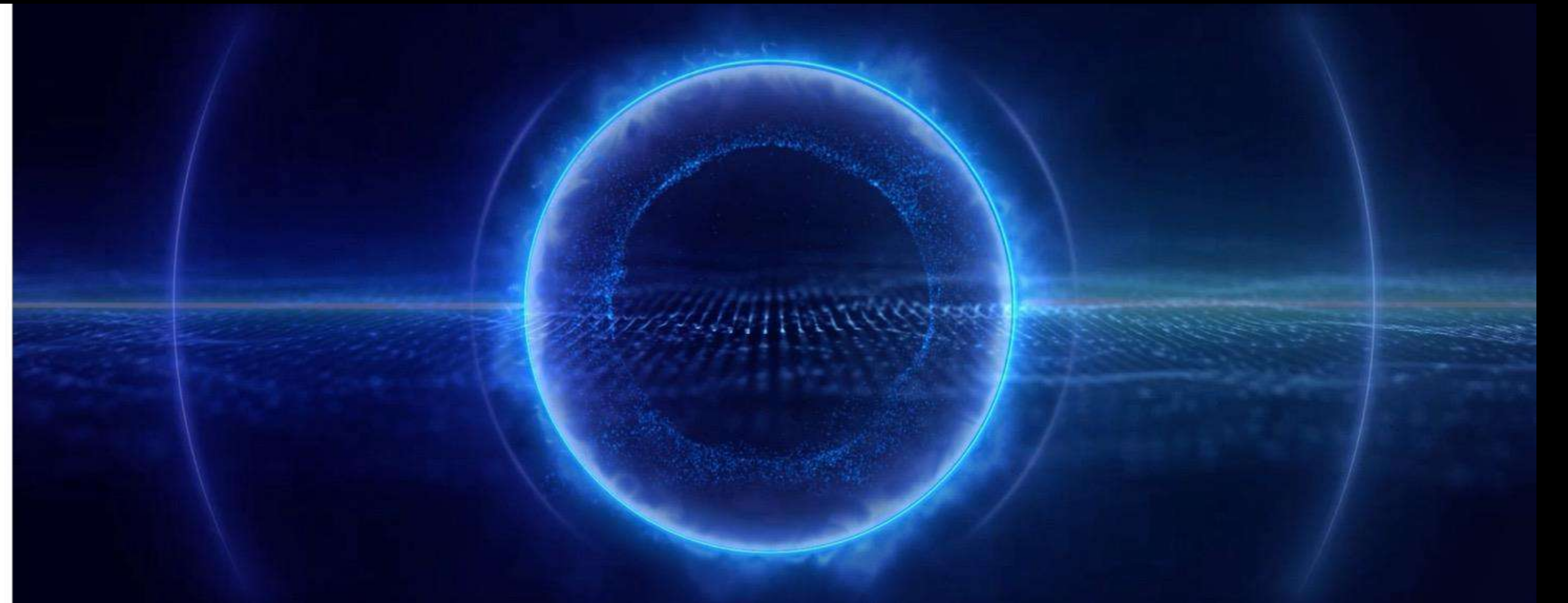

FROM ECO TO EGO

Multi Drive Modes Range, Everyday, Race

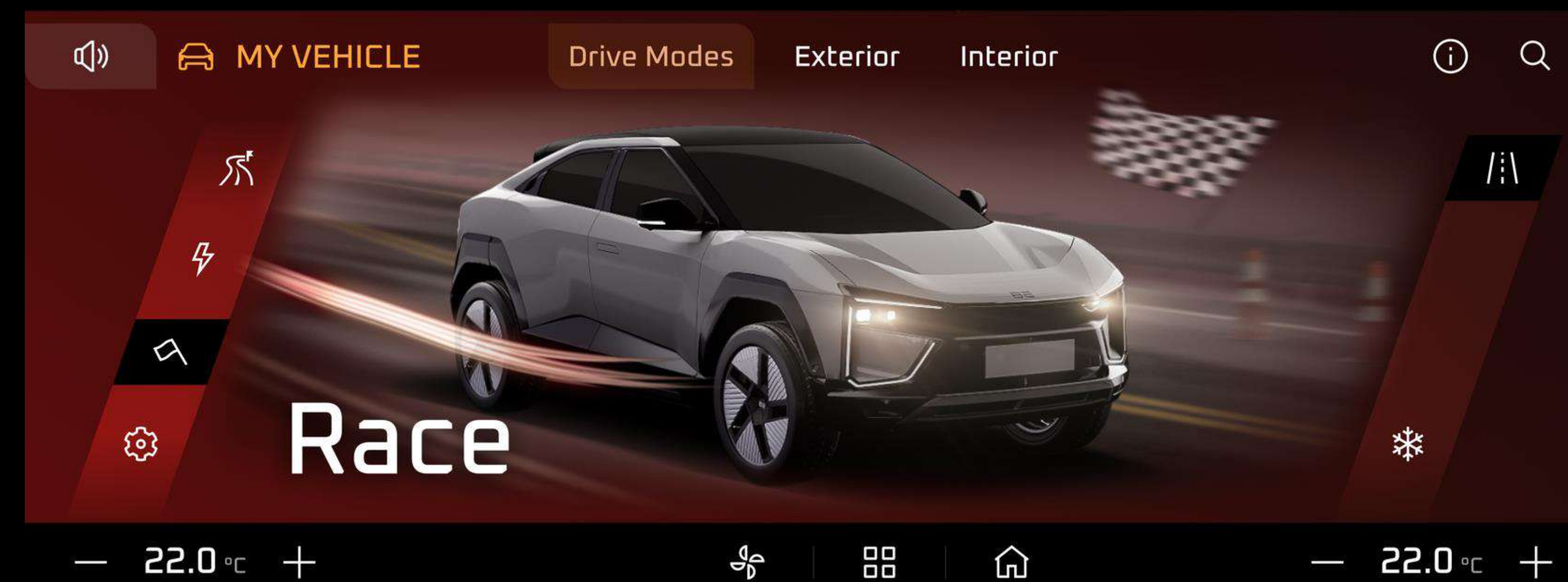
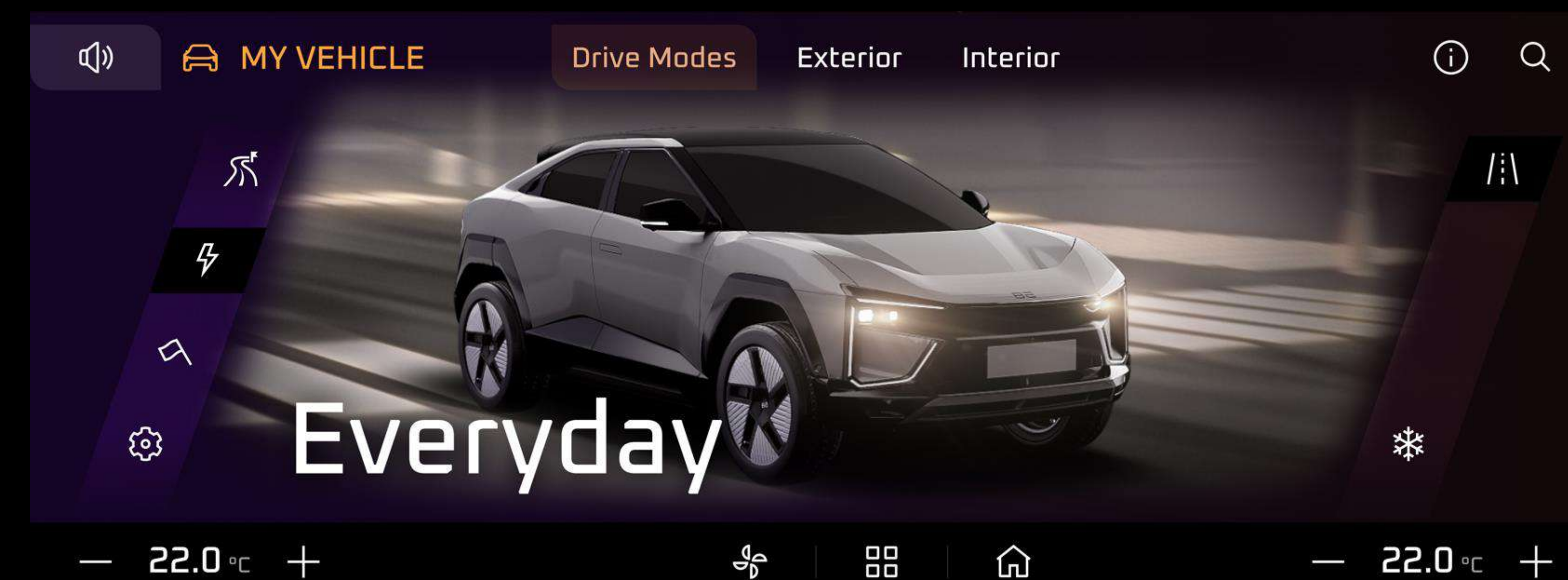
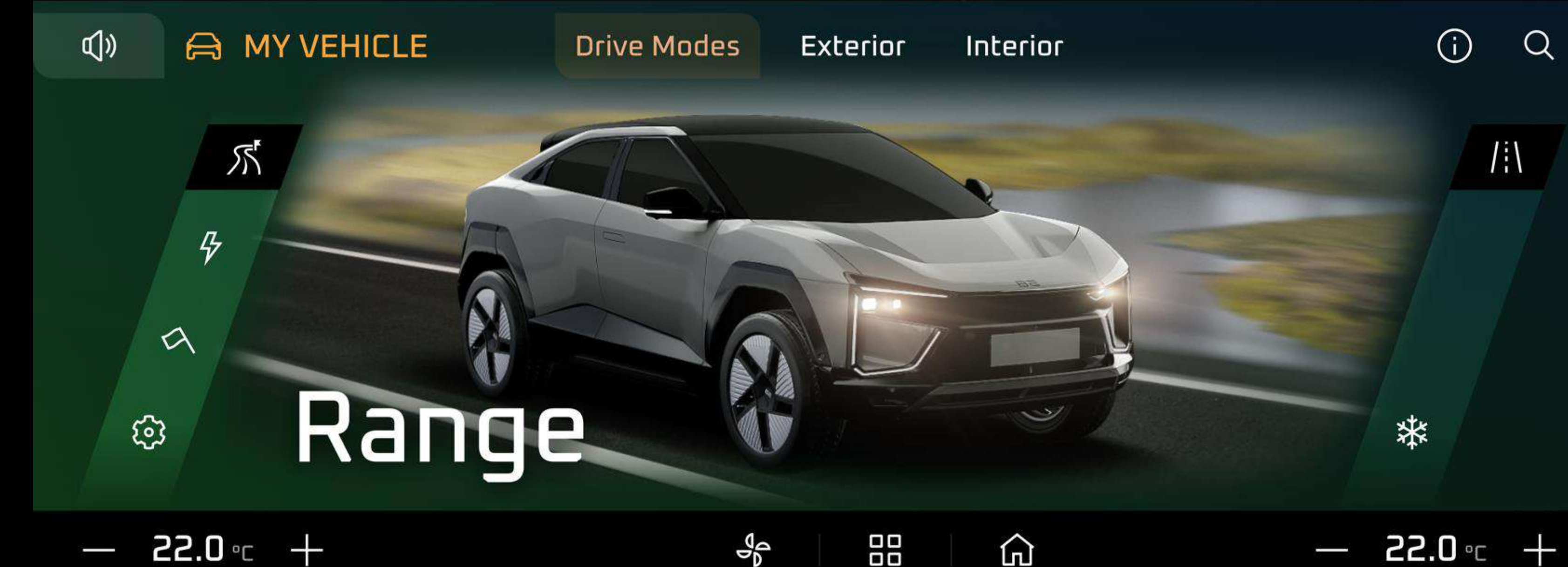

LOVE'S GOT YOUR BACK
& FRONT & SIDES

ADAS Level 2+
with 5 Radars
1 Vision System

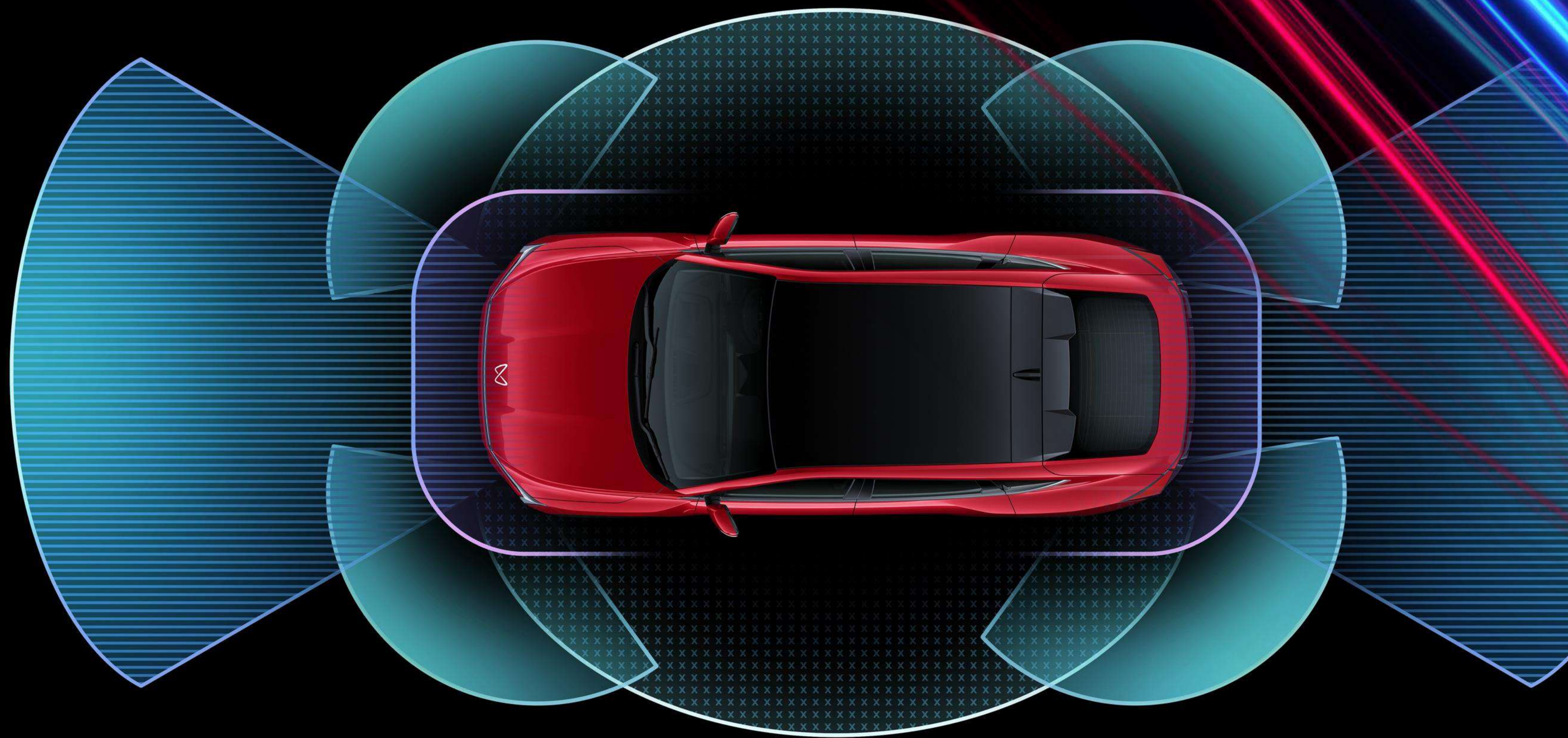

LOVE IS IN TUNE WITH
YOUR EVERY MOVE

EyeDentity
A wide FOV camera that
tracks fatigue and sends
alerts

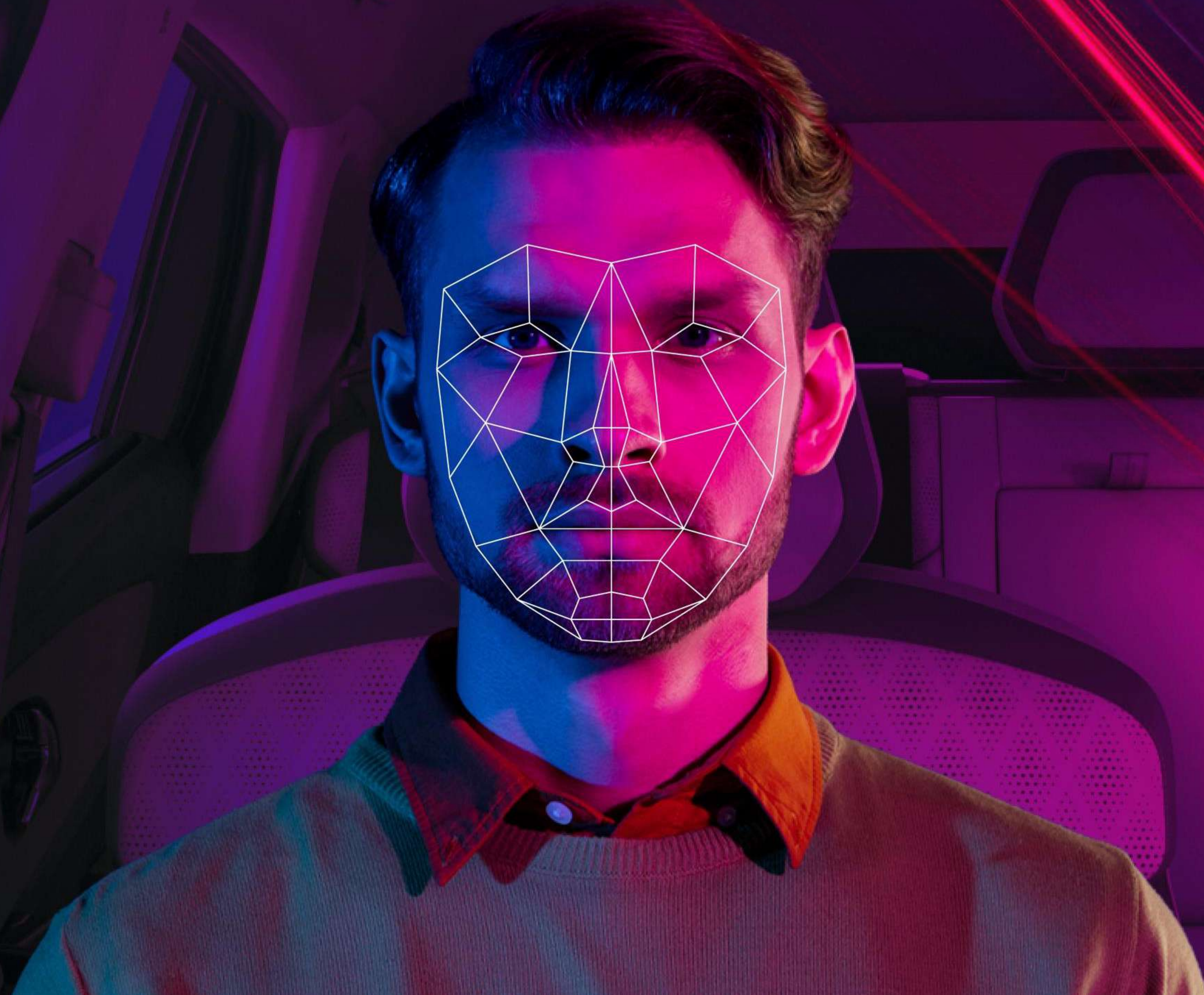

LOVE'S WATCHING,
EVEN WHEN YOU'RE NOT

Secure360 5 cameras for that Z-class security



LOVE WILL ALWAYS FIND A WAY

AutoPark 200+ spots in 1 touch

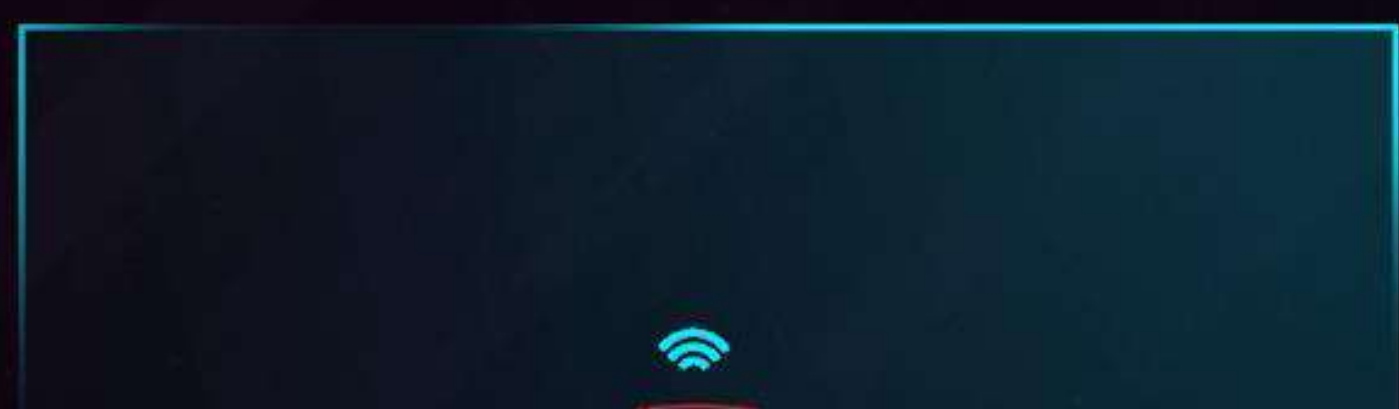
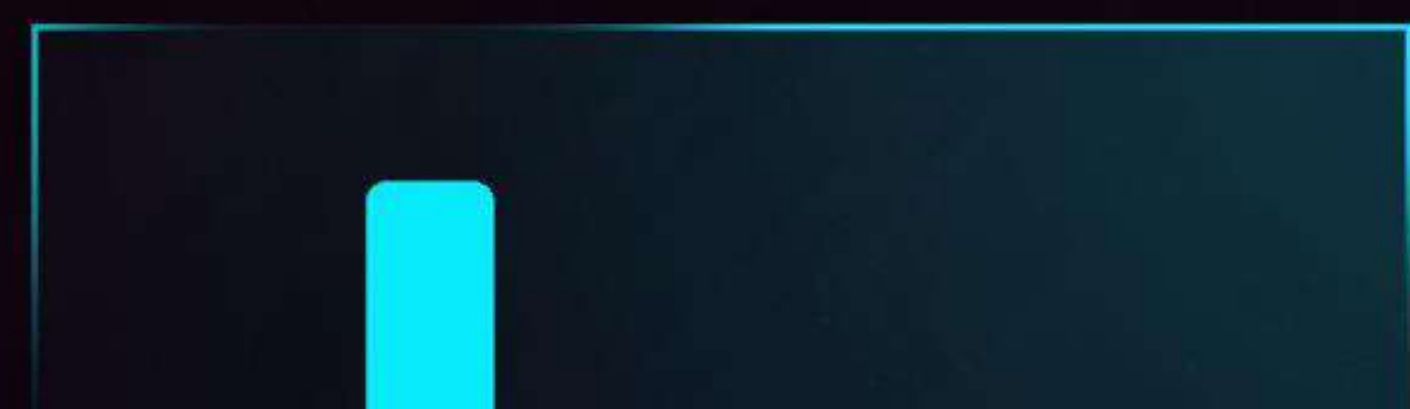
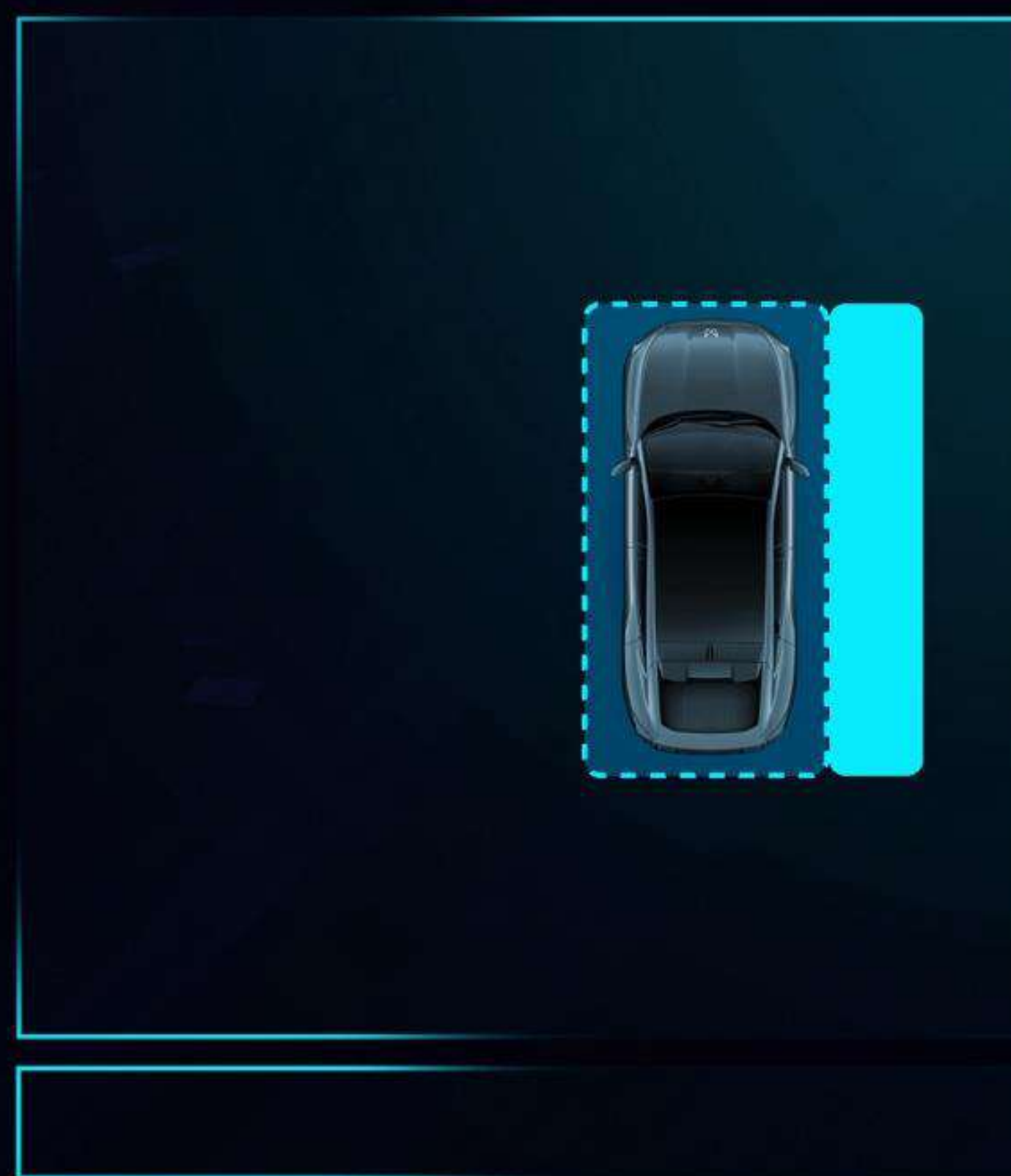
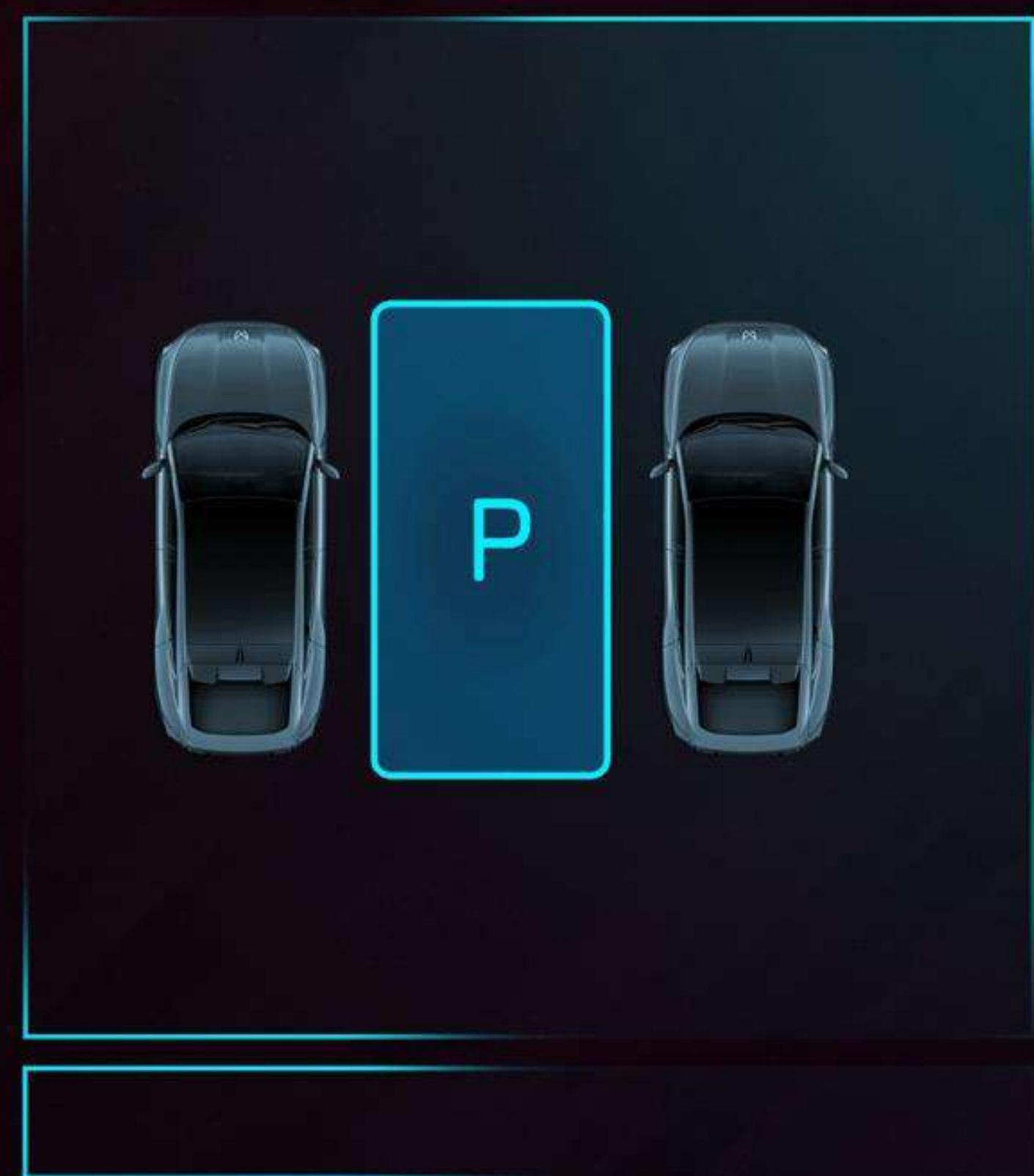
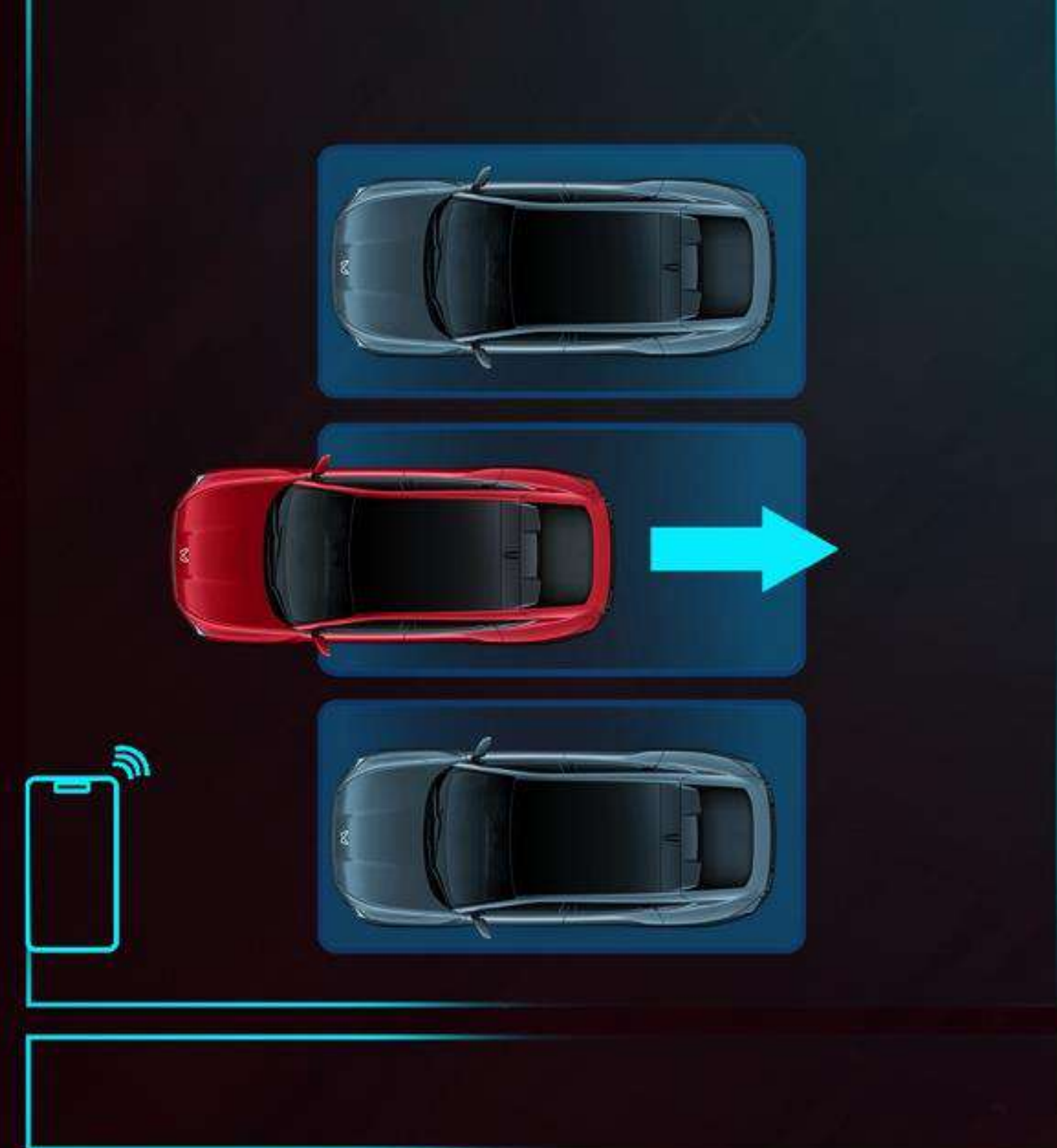

GO TO MARKET

WONDER ON WHEELS

500 people from luxury & premium brands to provide pre-purchase drive experience

A strong team of 400 tech-experts for seamless customer experience

OTA for seamless product experience



CHARGE_{EV}IN

BY mahindra

Industry-first Relationship
Manager

350+ strong dedicated team



GO TO MARKET

GTM starts in a phased manner in
the latter part of Jan'25

Delivery from end
Feb'25- Mar'25



Media Tech Day

7th and 8th Jan 2025

Chakan, Pune



The image features a central graphic with the text "UNLIMIT INDIA" in a white, stylized, sans-serif font. The text is centered between two sets of concentric, glowing rings. The rings on the left are primarily blue and cyan, while the rings on the right are primarily red and magenta. The background is a view of Earth from space, showing the horizon and a bright sun or starburst in the center, creating a lens flare effect. The overall composition is symmetrical and futuristic.

UNLIMIT INDIA

Opportunity Sizing

UV1 Industry

Relevant Universe* is 44k per month

Sale of Top 2 Variants is 23k per month (50% of the relevant universe)

Top 2 variants avg on road price is ₹21.7L#

* Excluding MPVs such as Ertiga, Rumion

On road price Chennai

በ፲ ልዩ

ONE



BE 6E



Performance

59 kWh Battery Pack

Superfast Charging Capability:
20 to 80% in just 20 mins with
140 kW DC Charger

Best-in-class Power of 170 kW

Electric Power Steering with
Variable Gear Ratio

10 metre Turning Circle Diameter

Multiple Driving Modes with Boost Mode

One-touch Single Pedal Drive

SonicSuite with Virtual Engine Sounds

iLink Front Suspension & 5-Link Rear
Suspension

MTV-CL technology

Frequency Dependent Damping

Low Rolling Resistance Tyres

Cruise Control

Design

Race-ready Digital Cockpit

Illuminated Logo

Bi-LED Headlamps with DRLs

LED Tail lamps

Premium Fabric Upholstery

Stylish R18 Wheels with Aero Covers

Premium Finish Exterior Cladding

Safety

6 Airbags

High Stiffness Bodyshell

All Wheel Disc Brakes

Brake-by-Wire Tech

Intelligent Electronic Brake Booster with 46
Value Added Features

Driver Drowsiness Detection

Electronic Parking Brake

Rear Parking Sensors with HD Camera

Low Tyre Pressure Indication

Technology

Dual Super Screens

Qualcomm Snapdragon Chipset

Wireless Android Auto & Apple CarPlay

Superfast 5G Connectivity

Pre-installed OTT, Social Media, News,
Shopping Apps

BYOD In-Car experience

Connected Features like Cabin Precooling,
Scheduled Charging

4 Speakers & 2 Tweeters

Built-in Amazon Alexa

STANDOUT FEATURES

Comfort & Convenience

Push Button Start

Spacious Frunk & Trunk

Auto Headlamps

Rain Sensing Smart Wipers

FATC with Rear AC Vents

Height Adjustable Driver Seat
& Seat Belt

Tilt & Telescopic Steering

Silent Tyres with NVH Reduction Tech

Cooled Console Storage

65 W Type C Fast Charging Ports
for Front & Rear

60:40 Split in 2nd Row Seats with
2-Step Recline

BE6E

INTRODUCTORY EX-SHOWROOM PRICE



₹ 18.90 Lakh

TERMS :

Above price does not include charger & Installation cost

Two charger options of 7.3 kWh and 11.2 kWh will be made available on chargeable basis.

BE6E



INTRODUCTORY PRICE

INDICATIVE ON-ROAD IN CHENNAI

₹ 20.36 Lakh

Conditions:

On road prices will vary based on state policy on taxation, registration and road tax

On road prices assumes 7% insurance premium and 1% TCS

Above price does not include charger & Installation cost

Two charger options of 7.3 kWh and 11.2 kWh will be made available on chargeable basis.

UV 2 & 3 Industry

Relevant universe* is 42k per month

Sale of Top 2 Variants is 18k per month (45%)

Top 2 variants avg on road price ₹30.2L #

* Excluding XL6

On road price Chennai

XEV 90



XEV 9e



Performance

- 59 kWh Battery Pack
- Superfast Charging Capability:
20 to 80% in just 20 mins with
140 kW DC Charger
- Best-in-class Power of 170 kW
- Electric Power Steering with
Variable Gear Ratio
- 10 metre Turning Circle Diameter
- Multiple Driving Modes with Boost Mode
- One-touch Single Pedal Drive
- SonicSuite with Virtual Engine Sounds
- iLink Front Suspension & 5-Link Rear
Suspension
- MTV-CL technology
- Frequency Dependent Damping
- Low Rolling Resistance Tyres
- Cruise Control

Design

- Illuminated Logo
- Bi-LED Headlamps
- LED Tail lamps
- Premium Fabric Upholstery
- Stylish R19 Wheels with Aero
Covers
- Premium Finish Exterior Cladding

Safety

- 6 Airbags
- High Stiffness Bodyshell
- All Wheel Disc Brakes
- Brake-by-Wire Tech
- Intelligent Electronic Brake Booster with
46 Value Added Features
- Driver Drowsiness Detection
- Electronic Parking Brake
- Rear Parking Sensors with HD Camera
- Low Tyre Pressure Indication

Technology

- Coast-to-Coast Triple Super Screens
- Qualcomm Snapdragon Chipset
- Wireless Android Auto & Apple
CarPlay
- Superfast 5G Connectivity
- Pre-installed OTT, Social Media, News,
Shopping Apps
- BYOD In-Car experience
- Connected Features like Cabin Precooling,
Scheduled Charging
- 4 Speakers & 2 Tweeters
- Built-in Amazon Alexa

STANDOUT FEATURES

Comfort & Convenience

- Push Button Start
- Spacious Frunk & Trunk
- Auto Headlamps
- Rain Sensing Smart Wipers
- FATC with Rear AC Vents
- Height Adjustable Driver Seat
& Seat Belt
- Tilt & Telescopic Steering
- Silent Tyres with NVH Reduction Tech
- Cooled Console Storage
- 65 W Type C Fast Charging Ports for Front
& Rear
- 60:40 Split in 2nd Row Seats with
Multi-Step Recline

XEV 9e

ONE



INTRODUCTORY EX-SHOWROOM PRICE

₹ 21.90 Lakh

TERMS :

Above price does not include charger & Installation cost

Two charger options of 7.3 kWh and 11.2 kWh will be made available on chargeable basis.

XEV 9e

ONE



INTRODUCTORY PRICE

INDICATIVE ON-ROAD IN CHENNAI

₹23.59 Lakh

Conditions:

On road prices will vary based on state policy on taxation, registration and road tax

On road prices assumes 7% insurance premium and 1% TCS

Above price does not include charger & Installation cost

Two charger options of 7.3 kWh and 11.2 kWh will be made available on chargeable basis.

